

## E2G Pressure Transducer

### FEATURES

- Ranges from 100 mbar through 1400 bar (20,000 psi)
- IP66/67 Ingress rating
- Wide selection of electrical & process connections available
- Customizable configurations
- External magnetic offset & span adjustment
- Barometric pressure ranges available (standard and custom ranges)

### TYPICAL USES

- Off-Road equipment
- Construction machinery
- HVAC/Refrigeration
- Compressor control
- Pump monitoring
- Agricultural equipment
- Diagnostic kits
- Engine monitoring
- Process automation & controls
- Hydraulic & pneumatic sensing

### PERFORMANCE SPECIFICATIONS

Reference Temperature: 21 °C ±2 °C (70 °F ±2 °F)

Static Accuracy: ±0.25 % of span, ±0.50 % of span, ±1.0 % of span (0...100 mbar range only available in ±0.50 % and ±1.0 % accuracy) Terminal Point Method includes: hysteresis, linearity, repeatability, offset and span

Stability: ≤±0.25 % of span/year at reference conditions

### ENVIRONMENTAL SPECIFICATIONS

Thermal Coefficients: Offset: ±0,09 % / 10 K (-40 bis 125 °C)  
Span: ±0,09 % / 10 K (-40 bis 125 °C)

Temperature Limits: Storage: -50 °C to 125 °C  
Operating: -40 °C to 125 °C  
Media: -40 °C to 125 °C

Humidity: 0-100 % R.H. (non-condensing)

### FUNCTIONAL SPECIFICATIONS

Response Time (Output): 4 ms

Gauge/Compound: -1 to 1400 bar  
Pressure Ranges: Vacuum to 20,000 psi (see Table 6 at page 7)

Shock: 80 g, 6 ms, Haversine

Vibration: Random: 10 g RMS 20-2000 Hz

Absolute Pressure Ranges: 0 to 1 up to 0 to 35 bar absolute  
0 to 500 psia

Pressure: Proof: 1,2x to 2x  
Burst: 3x to 8x  
(see Table 1 at page 2)



**E2G**  
Pressure Transducer



### KEY BENEFITS

- Highly configurable
- Easy calibration of offset and span

### ELECTRICAL SPECIFICATIONS

Circuit Protection: Reverse polarity protected

Output Signal:	Supply Voltage: (unregulated)	
	Min.	Max
0-5 Vdc (3 Wire)	9 Vdc	36 Vdc
1-5 Vdc (3 Wire)	9 Vdc	36 Vdc
1-6 Vdc (3 Wire)	9 Vdc	36 Vdc
0-10 Vdc (3 Wire)	14 Vdc	36 Vdc
1-11 Vdc (3 Wire)	14 Vdc	36 Vdc
0,1-5 Vdc (3 Wire)	9 Vdc	36 Vdc
0,1-10 Vdc (3 Wire)	14 Vdc	36 Vdc
0,5-4,5 Vdc (3 Wire)	9 Vdc	36 Vdc
4-20 mA (2 Wire)	9 Vdc	36 Vdc
20-4 mA (2 Wire)	9 Vdc	36 Vdc

Adjustability: ±5% of span non-interactive offset & span

Supply Current: <8 mA (Vout)

Current Source/Sink for Voltage Output: 1 mA (source)/ 0,1 mA (sink) MAX.

Withstand/Breakdown: 100 Vdc/Vac, optional 500 Vdc/Vac

## E2G Pressure Transducer

### PHYSICAL SPECIFICATIONS

Ingress Rating: IP66 (NEMA 4X) (STD.)  
 IP67 (IP69K Consult Factory)

### WETTED MATERIAL

Diaphragm: Sensor: Material:  
 A 17-4PH Stainless steel  
 B 316L Stainless steel (1.4404)  
 C 316L Stainless steel, liquid isolated (1.4404)  
 D A286

Process Connection: Stainless steel 316L (1.4404)

### NON-WETTED MATERIAL

Housing: Stainless steel 316L (1.4404)

### APPROVALS

EMC: CE Industrial EN 61326-1, EN 61326-2-3, EN 61326-3

Immunity: EN 61000-4-2 ±4 kV/±8 kV (air discharge) (ESD)  
 EN 61000-4-3 10 V/m to 1 GHz, 3 V/m to 2 GHz, 1 V/m to 2.7 GHz (Radiated RF)  
 EN 61000-4-4 ±1 kV (5/50 ns, 5 kHz) (EFT/Burst)  
 EN 61000-4-5 ±1 kV, Earth to Shield over all I/O lines (Surge)  
 EN 61000-4-6 3 V/ (0.15 to 80 MHz) (Conducted RF)  
 EN 61000-4-8 30 A/m (Line Freq. Magnetic)

RoHS: 2011/65/EU

Emissions: EN55011 (CISPR 11) Class A, Group 1  
 FCC (47 CFR 15)

CE, UL/ cUL Recognized component (UL 61010-1, CSA 22.2 61010-1),  
 Electrical Equipment for Measurement, Control, and Laboratory Use.



### What Does It Mean?

Ashcroft's TruAccuracy™ specification is exclusively based on terminal point methodology instead of statistically derived schemes like 'best fit straight line'.

TruAccuracy™ means the Ashcroft E2G has ±0.25% of span accuracy out of the box. Zero and span setting errors are already included in the ±0.25% of span accuracy spec.

The E2G is ready to be installed with no additional calibration adjustments required.

A unit from another manufacturer advertised as ±0.25% best fit straight line may actually be a ±1.25% to ±2.25% device. Using best fit straight line method, the accuracy spec does not include zero and span setting errors, which can be as much as ±1.00% each.

### TABLE 1: PROOF & BURST PRESSURE MULTIPLIERS

Sensor Range	A Sensor - 17-4PH SS		B Sensor - 316 LSS		Sensor C - 316L SS ISO		Sensor D - A286	
	Proof	Burst	Proof	Burst	Proof	Burst	Proof	Burst
(psi)								
1.5					2x	5x		
5					3x	5x		
10					2x	5x		
15					2x	5x		
30					2x	5x		
45	2x	8x	1.5x	8x	2x	5x		
50	2x	8x	1.5x	8x	2x	5x		
60	2x	8x	1.5x	8x	2x	5x		
75	2x	8x	1.5x	8x	2x	5x		
100	2x	8x	1.5x	8x	2x	5x		
150	2x	8x	1.5x	8x	2x	4x		
200	2x	8x	1.5x	8x	2x	3x		
300	2x	8x	1.5x	8x	2x	3x		
500	2x	8x	1.2x	5x	3x	4x		
750	2x	8x	1.2x	5x				
1000	2x	8x	1.2x	5x				
1500	2x	8x	1.2x	5x				
2000	2x	8x	1.2x	5x				
3000	2x	5x	1.2x	5x				
5000	1.5x	5x	1.2x	5x			1.5x	5x
7500	1.5x	3x					1.5x	5x
10000	1.2x	3x					1.2x	5x
15000	1.2x	3x					1.2x	5x
20000	1.2x	3x					1.2x	5x
(Compound)								
VAC#					2x	5x		
V&15#					2x	5x		
V&30#					2x	5x		
V&45#	2x	8x	1.5x	8x				
V&60#	2x	8x	1.5x	8x	2x	5x		
V&100#	2x	8x	1.5x	8x				
V&150#	2x	8x	1.5x	8x	2x	4x		
V&200#	2x	8x	1.5x	8x				
V&300#	2x	8x	1.5x	8x	2x	3x		
(psia)								
15					2x	5x		
30					2x	5x		
70					2x	5x		
150					2x	4x		
300					2x	3x		
500					2x	3x		



## E2G Pressure Transducer

ORDERING CODE	EXAMPLE:	E2G	B	3	C	MG4	42	DA	X	10	M	10BR	XNH
<b>Model</b>	E2G Pressure Transducer; General Purpose	E2G											
<b>Sensor Materials - See Table 3 on page 4 for compatible ranges</b>													
A	17-4PH Stainless steel		B										
B	316L Stainless steel (1.4404)												
C	316L Stainless steel (1.4404); liquid isolated												
D	A286												
<b>Accuracy</b>													
3	0,25 % of span (not available for pressure range 0 ... 100 mbar)			3									
5	0,50 % of span												
7	1,00 % of span												
X	According customer specification												
<b>Calibration Chart</b>													
N	Without calibration chart												
C	With calibration chart				C								
<b>Pressure Connections - See Table 3 on page 5 for more connection styles</b>													
MG4	G 1/2 B Female (EN837-1)					MG4							
<b>Output Type</b>													
05	0-5 Vdc												
10	0-10 Vdc												
11	1-11 Vdc												
12	1-10 Vdc												
13	0.1-5 Vdc												
15	1-5 Vdc												
16	1-6 Vdc												
42	4-20 mA						42						
45	0.5-4.5 Vdc non-ratiometric												
00	Custom												
<b>Electrical Connections - See Table 4 on page 6 for more options</b>													
DA	Hirschmann angle connector acc. EN175301-803 Form A							DA					
<b>Mating Connector</b>													
M	With mating connector												
X	Without mating connector								X				
<b>Cable Length</b>													
Max cable length of 9 m (30ft) for outputs 05, 10, 11, 12, 13, 15, 16 and 45. Max cable length of 30 m (99ft) for outputs 24 and 42													
00	No cable												
XX	01 to 99									10			
<b>Unit of Length</b>													
F	Feet											M	
M	Meter												
N	Inches												
0	No cables												
<b>Pressure Ranges - Coding example only, see Table 5 on page 7 for more options</b>													
10BR	10 bar											10BR	
<b>Options (If choosing an option(s) must include a "X")</b>													
<b>Cleaning</b>													
6B	Cleaned for oxygen application												
6W	Cleaned for oxidizing processes other than Oxygen												
<b>Marking/Tagging</b>													
NH	Stainless steel tag wired (Information is required by the customer)												XNH
NN	Paper tag (Information is required by the customer)												
<b>Others</b>													
TU	Throttle plug												
<b>Testing/Certificates</b>													
CD2	Certificate according to EN 10204 2.2												

Datenblatt



## E2G Pressure Transducer

### ACCESSORY

Offset and Span Adjustment Magnet 266A143-01

Accessories must be ordered separately

**TABLE 2 - SENSOR PRESSURE RANGE**

psi	Sensor Material				bar	Sensor Material				inHg	Sensor Material			
	A 17-PH	B 316L	C 316 ISO	D A286		A 17-PH	B 316L	C 316 ISO	D A286		A 17-PH	B 316L	C 316 ISO	D A286
1.5#			•		100MB			•		3IM			•	
5#			•		400MB			•		10IM			•	
10#			•		600MB			•		20IM			•	
15#			•		1BR			•		30IM			•	
30#	•		•		1.6BR			•		50IM			•	
45#	•	•	•		2BR			•		100IM	•	•	•	
50#	•	•	•		2.5BR	•	•	•		200IM	•	•	•	
60#	•	•	•		4BR	•	•	•		300IM	•	•	•	
75#	•	•	•		6BR	•	•	•		500IM	•	•	•	
100#	•	•	•		10BR	•	•	•		1000IM	•	•		
150#	•	•	•		16BR	•	•	•		VACIM			•	
200#	•	•	•		20BR	•	•	•		V&30IM			•	
250#	•	•	•		25BR	•	•	•		V&60IM			•	
300#	•	•	•		40BR	•	•			V&100IM	•	•	•	
500#	•	•	•		60BR	•	•			V&200IM	•	•	•	
750#	•	•			100BR	•	•			30IMA			•	
1000#	•	•			160BR	•	•			50IMA			•	
1500#	•	•			200BR	•	•			100IMA			•	
2000#	•	•			250BR	•			•	200IMA			•	
2500#	•	•			400BR	•			•	300IMA			•	
3000#	•	•			600BR	•			•	500IMA			•	
5000#	•	•		•	1000BR	•				1000IMA			•	
7500#	•			•	VACBR			•						
10000#	•			•	V&1BR			•						
15000#	•			•	V&1.6BR			•						
20000#	•			•	V&2BR			•						
VAC#			•		V&4BR	•	•	•						
V&15#			•		V&6BR	•	•	•						
V&30#			•		1BRA			•						
V&45#	•	•	•		1.6BRA			•						
V&60#	•	•	•		2BRA			•						
V&100#	•	•	•		2.5BRA			•						
V&150#	•	•	•		4BRA			•						
V&200#	•	•	•		6BRA			•						
V&300#	•	•	•		10BRA			•						
15#A			•		16BRA			•						
30#A			•		20BRA			•						
50#A			•											
100#A			•											
120#A			•											
300#A			•											

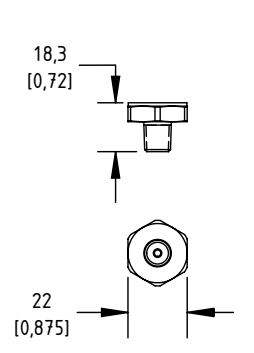
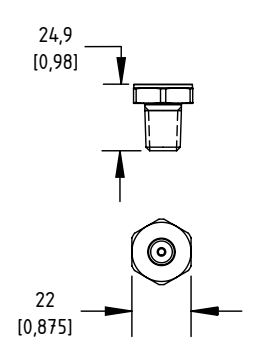
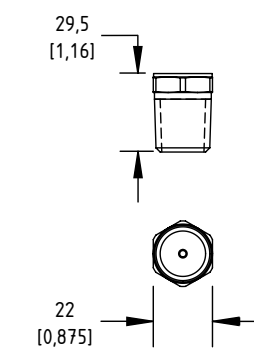
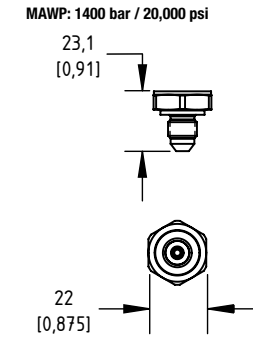
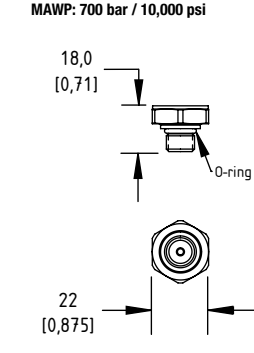
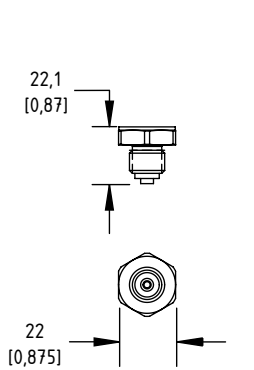
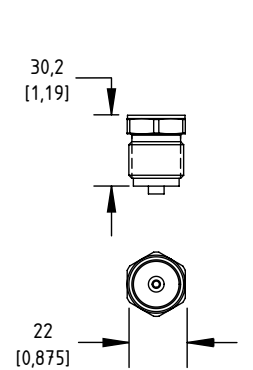
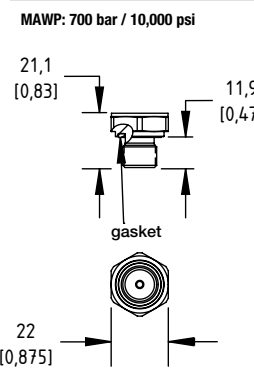
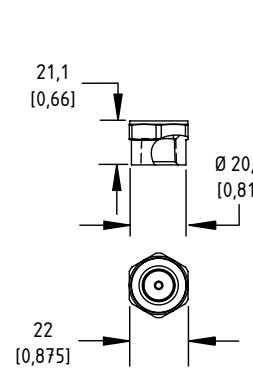
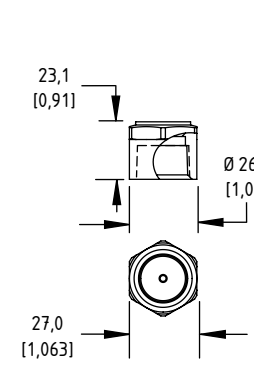
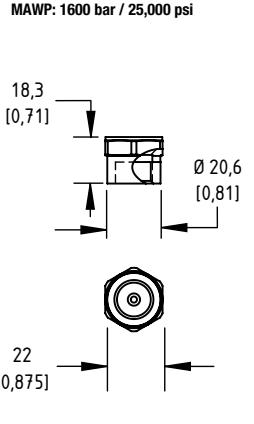
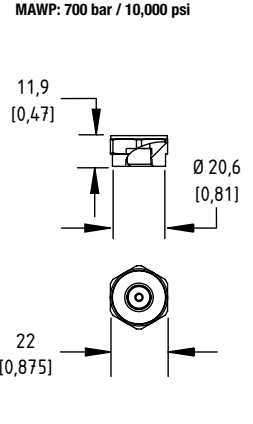
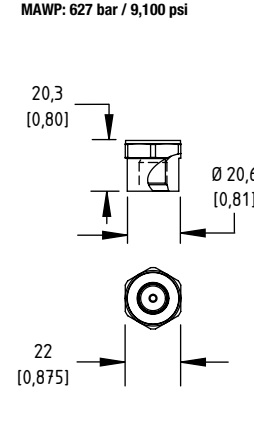
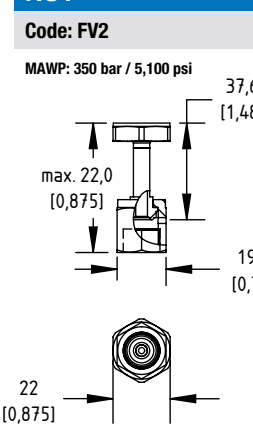
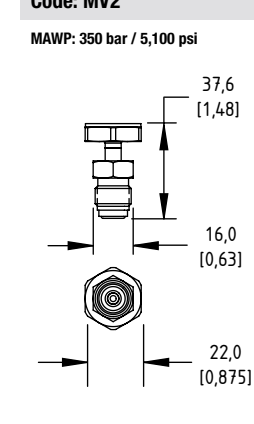

**E2G Pressure Transducer**
**TABLE 3 - PRESSURE CONNECTION DIMENSIONS IN MM [INCH]**

<b>1/8 NPT MALE</b> <b>Code: M01</b> MAWP: 1400 bar / 20,000 psi	<b>1/4 NPT MALE</b> <b>Code: M02</b> MAWP: 1400 bar / 20,000 psi	<b>1/2 NPT MALE</b> <b>Code: M04</b> MAWP: 700 bar / 10,000 psi	<b>7/16-20 UNJF-3A 37° FLARE (SAE AS4395)</b> <b>Code: M76</b> MAWP: 1400 bar / 20,000 psi	<b>7/16-20 UNJF-2A SAE-MALE (SAE J1926 O-RING BOSS SEAL)</b> <b>Code: MEK</b> MAWP: 700 bar / 10,000 psi
				
<b>G 1/4 B-MALE (EN837-1)</b> <b>Code: MG2</b> MAWP: 1400 bar / 20,000 psi	<b>G 1/2 B MALE (EN837-1)</b> <b>Code: MG4</b> MAWP: 1400 bar / 20,000 psi	<b>G 1/2 A-MALE (STUD END DIN 3852-E)</b> <b>Code: MGA</b> MAWP: 700 bar / 10,000 psi	<b>1/4-18 NPT FEMALE</b> <b>Code: F02</b> MAWP: 700 bar / 10,000 psi	<b>1/2-14 NPT FEMALE</b> <b>Code: F04</b> MAWP: 345 bar / 5,000 psi
				
<b>9/16-18 UNF-2B FEMALE</b> <b>Code: F09</b> MAWP: 1600 bar / 25,000 psi	<b>1/8 -27 NPT FEMALE</b> <b>Code: F01</b> MAWP: 700 bar / 10,000 psi	<b>7/16-20 UNF-2B SAEJ1926</b> <b>Code: FRW</b> MAWP: 627 bar / 9,100 psi	<b>1/4" VCR GLAND WITH 9/16-18 FEMALE SWIVEL NUT</b> <b>Code: FV2</b> MAWP: 350 bar / 5,100 psi	<b>1/4" VCR GLAND WITH 9/16-18 MALE SWIVEL NUT</b> <b>Code: MV2</b> MAWP: 350 bar / 5,100 psi
				



**E2G Pressure Transducer**
**TABLE 4 - ELECTRICAL CONNECTION DIMENSIONS IN MM [INCH]**

Maximum temperature range listed

**METRI PACK 3-PIN**
**Code: GN – IP67 (NEMA 4X)**

-40 °C to 85 °C

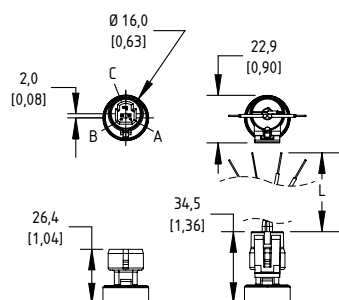
**AMP SUPERSEAL 3-PIN**
**Code: AP – IP66 (NEMA 4X)**

-40 °C to 85 °C

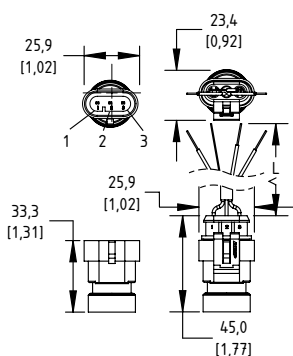
**OVER-MOLD CABLE**
**Code: FC, FV – IP67 (NEMA 4X)**

-40 °C to 85 °C

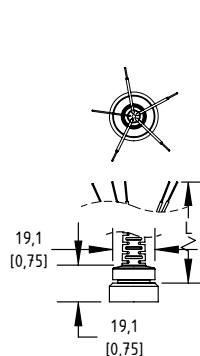
**M12 4-PIN**
**Code: EW, RW – IP66 (NEMA 4X)**

-40 °C to 85 °C

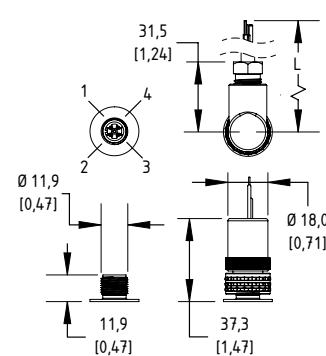
**DEUTSCH DT04 3-PIN**
**Code: DT – IP66 (NEMA 4X)**

-40 °C to 85 °C

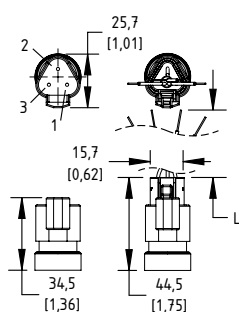
**HIRSCHMAN EN 175301-803 FORM A**
**Code: DA – IP66 (NEMA 4X)**

-40 °C to 85 °C

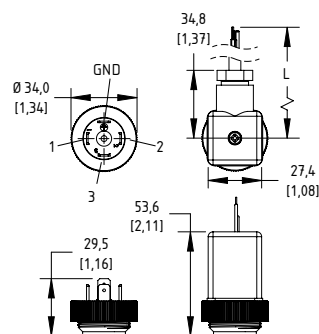
**MINI-HIRSCHMAN**
**Code: HM – IP66 (NEMA 4X)**

-40 °C to 85 °C

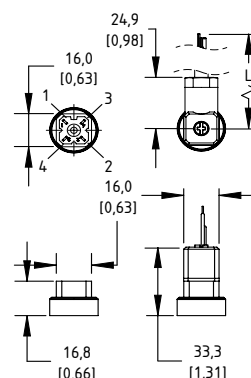
**MIL DTL 26482 8 4-PIN**
**Code: B4 – No IP or NEMA rating**

-25 °C to 105 °C

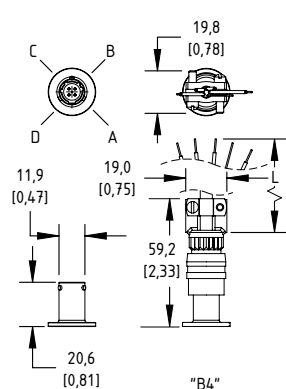
**HIRSCHMAN EN 175301-803 FORM C**
**Code: DC  
IP66 (NEMA 4X)**

-40 °C to 85 °C

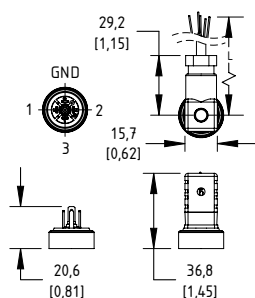
**M20 CONDUIT WITH CABLE**
**Code: MC, MV<sup>(1)</sup> –  
IP67 (NEMA 4X)**

-40 °C to 125 °C

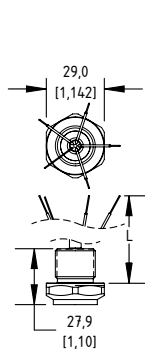
**1/2" NPT CONDUIT WITH CABLE**
**Code: CC, CV<sup>(1)</sup> –  
IP67 (NEMA 4X)**

-40 °C to 125 °C

**1/2" NPT CONDUIT WITH FLYING LEADS**
**Code: CF  
IP67 (NEMA 4X)**

-40 °C to 125 °C

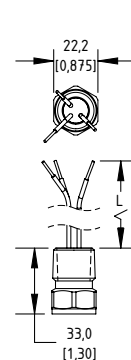
**M20 CONDUIT WITH FLYING LEADS**
**Code: MF  
IP67 (NEMA 4X)**

-40 °C to 125 °C

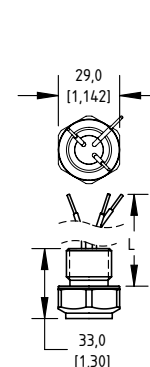

(1) indicates vented cable



**E2G Pressure Transducer**

**TABLE 5 - PRESSURE RANGES**

	PSI	bar	inHg	
Vac.	VAC#	VACBR	VACIM	
	V&15#	V&1BR	V&30IM	
	—	V&1.6BR	—	
Compound	V&30#	V&2BR	V&60IM	
	V&45#	—	V&100IM	
	V&60#	V&4BR	—	
	—	V&6BR	—	
	V&100#	—	V&200IM	
	V&150#	—	—	
	V&200#	—	—	
	V&300#	—	—	
	Positive Pressure (psig)	1.5#	100MB	3IM
		5#	400MB	10IM
—		600MB	—	
10#		—	20IM	
15#i		1BR	30IM	
—		1.6BR	50IM	
30#		2BR	—	
—		2.5BR	—	
45#		—	—	
50#		—	100IM	
60#		4BR	—	
75#		—	—	
—		6BR	—	
100#		—	200IM	
150#		10BR	300IM	
200#		—	—	
—		16BR	—	
250#		—	500IM	
300#		20BR	—	
—		25BR	—	
500#		—	1000IM	
—		40BR	—	
750#		—	—	
—		60BR	—	
1000#		—	—	
1500#		100BR	—	
2000#		160BR	—	
—		200BR	—	
2500#		—	—	
3000#		—	—	
—	250BR	—		
5000#	—	—		
—	400BR	—		
7500#	—	—		
—	600BR	—		
1000#	—	—		
15000#	1000BR	—		
20000#	—	—		
Absolute Pressure (psia)	15#A	1BRA	30IMA	
	—	1.6BRA	50IMA	
	30#A	2BRA	—	
	—	2.5BRA	—	
	50#A	—	100IMA	
	—	4BRA	—	
	—	6BRA	—	
	100#A	—	200IMA	
	—	10BRA	300IMA	
	200#A	—	—	
—	16BRA	500IMA		
—	20BRA	—		
500#A	—	—		

**DIMENSIONS IN MM [INCH]**

For reference only, consult Ashcroft for specific dimensional drawings

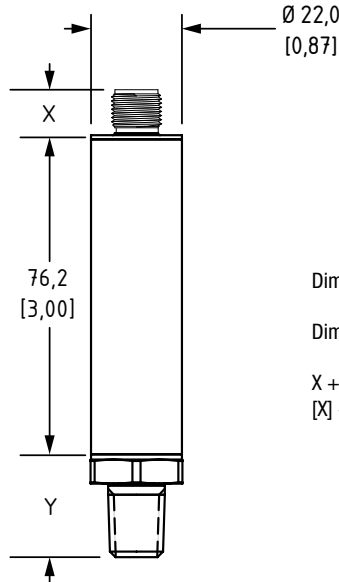

Dimensions for X can be found on page 6

Dimensions for Y can be found on page 5

$X + Y + 76.2 \text{ mm} = \text{total length in mm}$   
 $[X] + [Y] + 3.00" = \text{total length in inches}$



## E2G Pressure Transducer

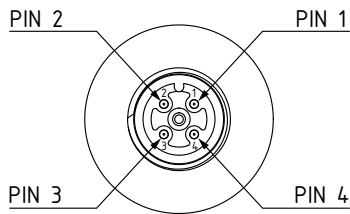

	PIN 1	PIN 2	PIN 3	PIN 4
<b>EW CURRENT</b>	V+	Case ground	V-	V-
<b>EW VOLTAGE</b>	V+	Case ground	Common	Output
<b>RW CURRENT</b>	V+	V-	Case ground	V-
<b>RW VOLTAGE</b>	V+	Output	Case ground	Common

**ALL OTHER PIN ASSIGNMENTS ARE SHOWN IN THE INSTRUCTION MANUAL**