

ASHCROFT ATE-2 Operation and Maintenance Manual

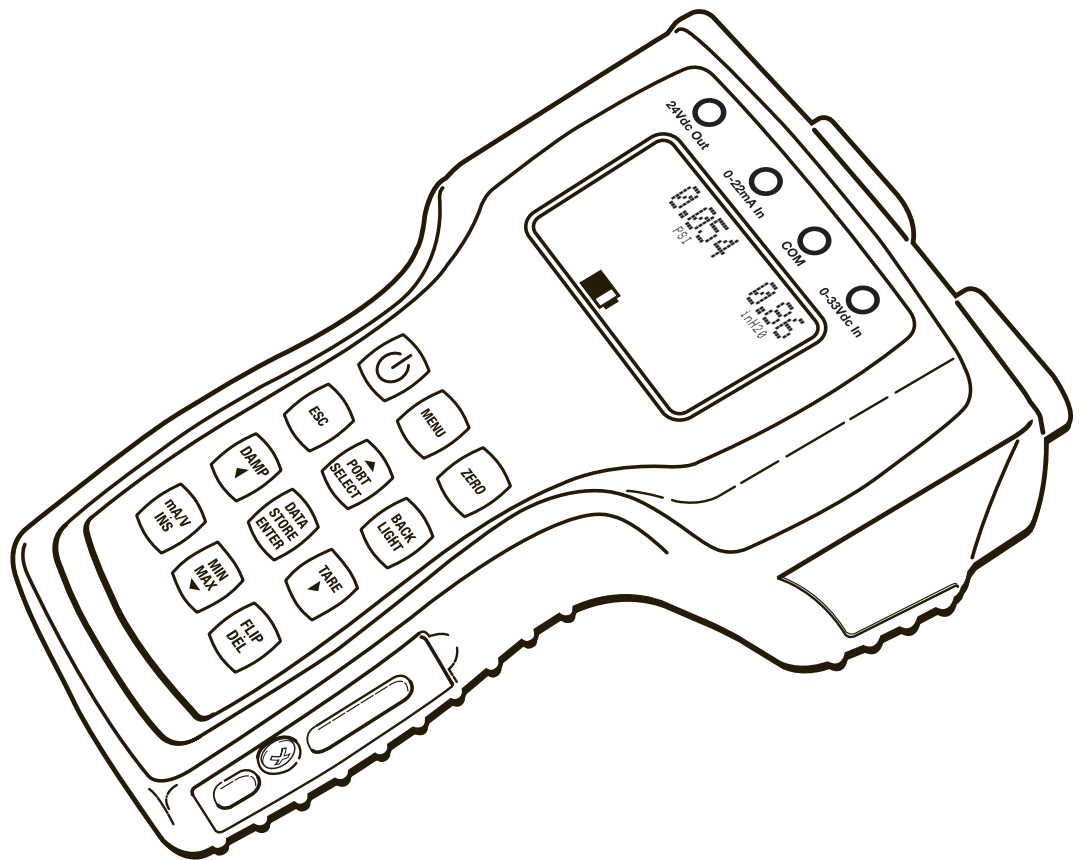

Congratulations on your purchase of a Ashcroft ATE-2, one of the finest precision pressure measuring instruments available anywhere. These instruments are precision devices, designed to measure, indicate pressure, temperature, DC voltage or current with an extremely high degree of accuracy and are rugged enough to provide laboratory performance in field service. All parts have been designed and selected for such service and with proper care and maintenance this instrument will perform within specifications for years of trouble free service.

TABLE OF CONTENTS

SECTION	TOPIC	PAGE
Section 1.	Warnings	3
Section 2.	Introduction	7
Section 3.	Specifications.....	8
Section 4.	Base Unit Overview	10
Section 5.	How To Obtain Programming Pass Codes.....	11
Section 6.	Module Overview	11
Section 7.	Unpacking	14
Section 8.	Storage	14
Section 9.	Cleaning	14
Section 10.	Battery Installation	14
Section 11.	Module Installation.....	15
Section 12.	Startup Basic Function	15
Section 13.	Key Function Overview	17
Section 14.	Measurement Mode Functions	
	a. ESC	18
	b. Port Select	18
	c. Data Storage.....	18
	d. Zero	18
	e. Back Light.....	18
	f. Damping	19
	g. Manual Datalogging.....	19
	h. Tare	20
	i. mA/V Monitoring.....	22
	j. Wiring Diagrams	22
	k. 24VDC Power Supply Enable/Disable	23
	l. Min/Max Function	24
Section 15.	MENU Mode Functions and Programming	25
	a. MENU Mode General Key Functions.....	25
	b. Base Unit Set Up	26
	i. Programming Date and Time.....	26
	ii. Programming Owner Name	27
	iii. Program Auto Off and Back Light Timers	27
	c. Engineering Units Selections.....	28
	d. H2O Temperature Conversion Selection.....	29
	e. Programing User Defined Unit of Measure	29
	f. Datalogging Setup	30
	i. Set Channel Tag Names	31
	ii. Program Auto Datalog Time.....	31
	iii. Initiate Auto Datalogging.....	32
	iv. Initiate Manual Datalog	32
	v. Review Datalog Data	33
	vi. Export Data to SD Card.....	35
	vii. Clear Internal Memory Storage	35

TABLE OF CONTENTS (cont.)

g. Switch Test.....	35
h. Percent (%) Error Function	37
i. Dual Mode Functions.....	41
j. RTD Temperature Measurement.....	42
k. Thermocouple Temperature Measurement.....	45
l. Firmware Update	47
m. Communications Interface	55
i. USB Cable Installation.....	55
ii. Driver Installation	56
iii. Terminal Set Up	58
iv. Inquiry Mode.....	59
v. Journal Mode.....	60
vi. ISO 1745 Mode.....	60
n. Calibrate Base Unit.....	60
o. Pressure Module Calibration	66
Section 16. Appendices	
A. Conversion Factor Table	71
B. Trouble Shooting and Error Codes	72
C. ISO Commands	77
D. RTD Probe Connections, TC External Reference Connection	79
E. System Accuracy With Thermocouple Interface	80
F. Approved SD Data Cards	80

GENERAL INFORMATION

The information in this manual pertains to Ashcroft ATE-2 Hand Held Calibrators; referred to as the HHC or ATE-2. This manual also covers sensing modules used with the HHC; referred to as AM2 modules.

This manual provides the following information:

- Precautions, Warnings and Safety Instructions
- Product Specifications
- Basic Maintenance
- Verification and Test Procedures
- Programming Instructions
- Calibration and Adjustment Procedures
- Accessories and Replaceable Parts

The ATE-2 is intended to perform the following functions

- Display one or two high accuracy pressure and/or temperature measurements
- Display one DC voltage or current value
- Record datalogs of the displayed measurements (up to 16,000 records on internal memory organized in up to 64 datalogs)
- Transfer datalogs to an onboard SD memory card
- Communicate directly to a PC via USB connection
- Allow for accurate measurement of various pressure and temperature ranges by use of interchangeable Quick-Select modules
- Allow for field recalibration of base unit and pressure modules.
- Provide power to devices from an internal 24Vdc loop supply (non-I.S. only)

TERMS IN THIS MANUAL

Terms used in this manual

- HHC or Base Unit refers to the Model ATE-2 Hand held Calibrator Base Unit
- Capacitive Module refers to Model AM2-1 low pressure sensor module
- Piezo Module or Piezoresistive Module refers to Model AM2-2 high pressure sensor module (Note the 10K psi range, only, uses a Polysilicon thin film sensor)
- Quick-Select Module refers to any pressure or temperature module model noted above

WARRANTY INFORMATION

All Ashcroft Products and Parts carry a warranty against defective material or workmanship for a period of one (1) year from the date of shipment. (See complete policy, page 81.)

Information provided in this document is for the use of qualified personnel only. Do not perform tests or calibrations described in this manual unless you are qualified to do so.

Use the ATE-2 calibrator only as described in the user manual, supplements and appendices.

SECTION 1.0

WARNINGS



WHEN YOU SEE THESE SYMBOLS



IMPORTANT APPLICATION INFORMATION



IMPORTANT SAFETY INFORMATION

**PURPOSE AND SCOPE
OF
MANUAL**



IMPORTANT

Please read the entire manual thoroughly before using the instrument or attempting any service or repair work. The instructions in this manual are intended to be performed by qualified instrumentation or technical personnel only. This manual should be kept with the instrument or in a place of safe keeping at all times, as it contains pertinent information for operation and maintenance. Additional manuals can be ordered through Customer Service. If additional assistance is needed, contact our Customer Service Staff at:

Ashcroft Inc.
250 East Main Street
Stratford, CT 06614-5145, USA
Tel: 203-378-8281
Fax: 203-385-0402
email: info@ashcroft.com

Please be sure to include instrument model number and serial number in all correspondence to assure proper identification. Ashcroft Inc. does not recommend trouble-shooting or repairs beyond the scope of this manual. Problems which cannot be remedied by following the instructions in this manual should be referred to the manufacturer. Immediate assistance can often be supplied by telephone. Defective components will be repaired or replaced by the manufacturer at his discretion. Repaired products will be returned to the user by the same mode of shipment. Air-mail and air express is recommended for urgent shipments.

Electronic pressure instruments must be selected in accordance with industry codes and safety practices to avoid the possibility of misuse or misapplication which could result in personal injury or property damage. Personnel responsible for selection and installation should also be familiar with the safety recommendations of ASME B40.1, that apply to elastic pressure elements and their application in general and specific services. ANSI B40.1 is available from:

ASME
345 East 47th Street
New York, NY 10017

SAFETY



PRECAUTIONS:

- Pressure – Select a range so that the maximum applied pressure will never exceed the upper range limit.
- Vibration – Excessive vibration could cause loosening of components resulting in loss of instrument accuracy or failure to provide valid data.
- Pulsation – Excessive pressure pulsation could result in fatigue failure of the pressure element.
- Temperature – Operation of the instrument in an environment where temperatures are in excess of design ratings may result in loss of accuracy and failure.
- Process – Pressure boundary materials must be resistant to the process media. Failure to assure compatibility may result in pressure sensing element deterioration or failure. Instruments used on high pressure gas, or potentially hazardous service, such as oxygen should be carefully selected in accordance with the recommendations of ANSI B40.1.
- Hazardous Location – Only approved explosion proof or intrinsically safe instruments should be used in hazardous locations.
- Electro-Magnetic Interference – Instruments should not be used in locations where EMI/RFI conditions exceed design ratings, to avoid erroneous performance.

WARNINGS CONT.



Warning to avoid shock or personal injury

- Follow all applicable equipment safety procedures.
- Inspect the calibrator before use. Do not use the calibrator if it appears damaged.
- Close battery door and secure with lock screw before using the calibrator.
- Check all test leads for continuity, damaged insulation or exposed metal. Replace any damaged leads.
- Use the proper terminals, mode and range for any measuring and sourcing application.
- Connect the common lead before connecting the live test leads.
- To prevent damage to the unit under test, be sure that the calibrator is in the correct mode before connecting leads.
- Never apply more than 33 volts between input terminals or between any terminal and ground.
- When using probes keep fingers away from probe contacts.
- Do not allow water or other liquids inside the calibrator case.
- Do not operate the calibrator near explosive gas or vapor unless the calibrator is marked as approved for hazardous area service.
- Never open the ATE-2. There are no field serviceable components. This will void the warranty.
- When measuring pressure, be sure that the process pressure line is shut off and depressurized before connecting or disconnecting a pressure module.
- Always use proper tools to avoid damage to pressure measurement modules. Use a wrench to hold the module manifold, and a second tool to tighten the mating fitting. See drawing figure in section 12.
- Replace batteries only with approved AA alkaline batteries (Quantity 4). Never mix new and used batteries in the calibrator.

ADDITIONAL WARNINGS



Warnings for Intrinsically Safe approved versions only

(Refer to Supplement I.S. Manual I&M002-10212)

- When marked as approved the ATE-2 calibrator is agency approved for use in areas when potentially flammable or explosive gas or vapor may occur. These areas are referred to as hazardous (classified) locations in the United States, as hazardous locations in Canada, as potentially explosive atmospheres in Europe and as explosive gas atmospheres in other parts of the world. The HHC's voltage and current input jacks have entity parameters and as such can be utilized in a hazardous location to connect to other apparatus as long as said apparatus meets the requirements of the entity parameters.
- When marked with the following Symbols the calibrator is approved by Factory Mutual (FM) for use in Class 1 Division 1, Groups A,B, C,D hazardous areas, by ATEX for use in Ex ia II C T4 Ga -20C<Ta<+50C and by CSA for use in Class 1, Division 1, Groups A, B, C, D

ADDITIONAL WARNINGS CONT.



ASHCROFT 250 EAST MAIN ST.
STRATFORD, CT 06614
www.ashcroft.com

INTRINSICALLY SAFE/SÈCURITÈ INTRINSÈQUE Exia
CL I, DIV 1, GR A, B, C, D. T4 -20°C ≤ Ta ≤ +50°C
Ex ia II 1 G FM12ATEX0035X

ENTITY PARAMETERS
Ui=33Vdc li=300mA Ci=0 Li=0 Pi=1.5W
Uo=5.735Vdc Io=586µA Co=46µf L0=1H Po=840µW

WARNING: See Dwg #825A028 for installation, batteries and warnings

HAND HELD CALIBRATOR 6D49 E171189
Unit contains a lithium battery. Panasonic #BR1225 is the approved replacement battery. Use of another battery may present a risk of fire or explosion. See owners manual for safety instructions.
Label Part# 238A746-01Rev D

- Before entering a hazardous area, close both the battery door and USB/SD card door, and secure both with lock screws.
- The battery access cover is not to be removed while in a hazardous area.
- The USB/SD access door is not to be removed while in a hazardous area.
- Replace batteries only in a non-hazardous area.
- Use only Duracell Model MN1500 AA alkaline primary cell batteries.
- The USB connection-data transmission and power input- are restricted to be used in a non-hazardous area only.
- The non-hazardous area USB apparatus –computer port, wall supply, etc., connected to the USB port of the HHC, must be assessed and conform to section 6.2.5 of EN60079-11. This precaution is to protect the integrity of the safety components within the HHC, which insures its intrinsic safety rating while in the hazardous location.
- When using non- assessed USB equipment, accessory part number 101C225-01, USB protection device, is to be inserted between the HHC USB port and the non-assessed apparatus.
- Do not power the calibrator by USB cable in a hazardous area; this action will invalidate the calibrator's intrinsic safety.
- Intrinsically safe installation diagrams, entity parameters and warnings are included in drawing 825A028 included in the supplemental I.S. manual.

The ATE-2 is a simple, yet sophisticated, high accuracy, battery or USB powered, handheld calibrator device. Used together with interchangeable pressure and temperature modules, this device measures, displays and can record pressure, temperature, DC voltage or milliamp current. Up to three measurements can be simultaneously displayed.

A standard system consists of a base unit and one or two Quick-Select modules.

Quick-Select pressure modules are available in over 50 standard pressure ranges in gauge, absolute, vacuum and compound ranges capable of measuring pressures from 0.25 inches water column up to 10,000 pounds per square inch.

Quick-Select temperature modules are designed to work with several common RTD types including Pt1000, Pt100, Ni120, Cu10, and up to six programmable resistance curves. Thermocouple temperature modules work with Types J, K, T, E, R, S, B and N thermocouples.

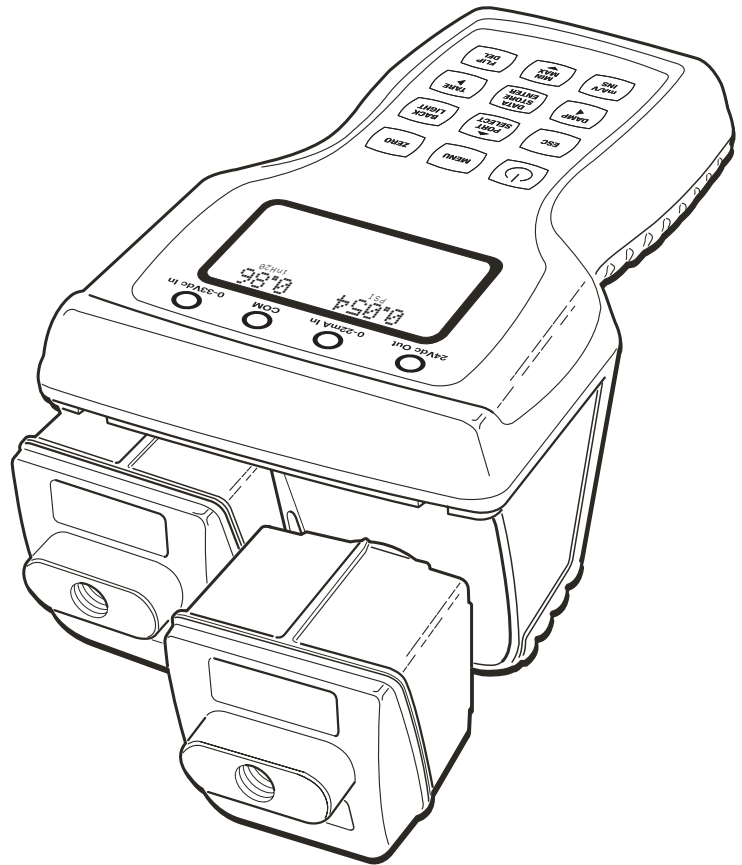

PRODUCT SPECIFICATIONS**BASE UNIT PHYSICAL SPECIFICATION**

Dimensions	8.7" L X 5.1" W X 3.8" H
Weight	2.4 pounds (includes two modules installed)
Case Material	High Impact PC-ABS with rubberized sections
Sensor Module Capacity	2, hot swappable, modules are fully recognized automatically
Display	1.5" X 2.5" Graphic LCD Display with backlight
Power Source/Requirements	4 x AA Batteries (6.4VDC maximum) Duracell Alkaline MN1500, or via USB port from PC or wall supply (5.25 VDC maximum, 0.375 Amps maximum)
Real Time Clock Battery	Panasonic BR1225, Lithium ion (not field replaceable)
Battery Life	50 hours with 1 module, with no back light at 70°F 40 hours with 2 modules, with no back light at 70°F
AC/DC adaptor (USB Port)	USB Micro-B Connector
Electrical Connection	4mm "Banana Jack" sockets, quantity 3 or 4
Electrical Output	24 VDC output, 35mA maximum
Current Input	0-22mA
Voltage Input	0-33 VDC
Interface	USB 2.0
Removable Data Storage	Type SD

BASE UNIT ENVIRONMENTAL SPECIFICATION

Temperature Effect	±.004%Sp / ° F over compensated range (+20/+120°F (-7/+50°C))	
Enclosure		
IP Rating (with modules)	NEMA 4X / IP65, suitable for Indoor and Outdoor use	
Impact / Drop Resistance	IEC 60079 - 0	
Warm-up time (to full accuracy)	Less than 5 min.	
Agency Approvals (w/modules)	CE	EMC Directive, IEC-61326-1: 200
	FCC	FCC CFR 47, Part 15, section 15.5 and 15.29
	UL	UL-61010-1, File # E171189
Optional Agency Approvals (with modules)	FM	Intrinsically Safe Class 1, Division 1, Groups A,B,C,D. FM Project #3043711
	CSA	Intrinsically Safe Class 1, Division 1, Groups A,B,C,D, CSA Report #150912-2653569
	ATEX	Ex ia II C T4 Ga -20C<Ta<+50C, File # FM12ATEX0035X

BASE UNIT PERFORMANCE SPECIFICATION

Update Rate	100 milliseconds per parameter measured. 300 milliseconds max when 2 modules and current/ voltage monitoring is active	
Resolution	± 0.001% of span, 99,999 counts (max, for 110% of pressure range)	
Interface	Serial USB, 2.0	ISO 1745
Electrical Measurements	Accuracy (% Span)	
	0-20 mA, or 0-30VDC (with auto-ranging)	
	0/10VDC	±0.025
	10/30VDC	±0.1
	0/20mA	±0.03
	Temp. Effect (%Span / F)	±0.001
Temperature Measurements	RTD or Thermocouple	
On-Board Power Source	24VDC, for use with 4-20mA & voltage output transducers 35ma maximum	
Compatible w/ Custom Firmware	Modbus (Optional), Medical Instrument Base (Optional)	
Flash Firm Ware upgrade through	USB Port possible. (Approximate update time 15 minutes)	

SECTION 3.0**PRODUCT SPECIFICATIONS CONT.**

Feature or Function	Activated from Key Pad	Activated from Menu
On/Off	X	
Backlight	X	
Esc	X	
Menu	X	
Flip Screen	X	
Navigation Keys (4)	X	
Port Select	X	
Zero	X	
mA / V	X	
Damping	X	
Tare Capability	X	
Min / Max Tracking	X	
Data-Logging w/auto start/auto stop		X
Field Calibration (Base Unit and pressure modules)		X
Passcode Lock		X
Selectable Eng. Units (12 pre-programmed and 1 user defined)		X
Trip Detect / Dead band Function		X
% Error Display		X
Dual Mode measurement (DP, Sum)		X
Loop Power Supply Activation (Non-Intrinsically Safe Only)		X
SD Memory Card Functions		X

The base unit functions as a host for the Quick-Select pressure and temperature modules. The base unit includes two bays for installation of pressure or temperature modules, an LCD graphic display with back light, a key pad, a USB micro B receptacle for communication with a PC, an SD memory card slot and banana jack connections for DC voltage supply and signal monitoring. The enclosure is rated to IP65 water resistant.

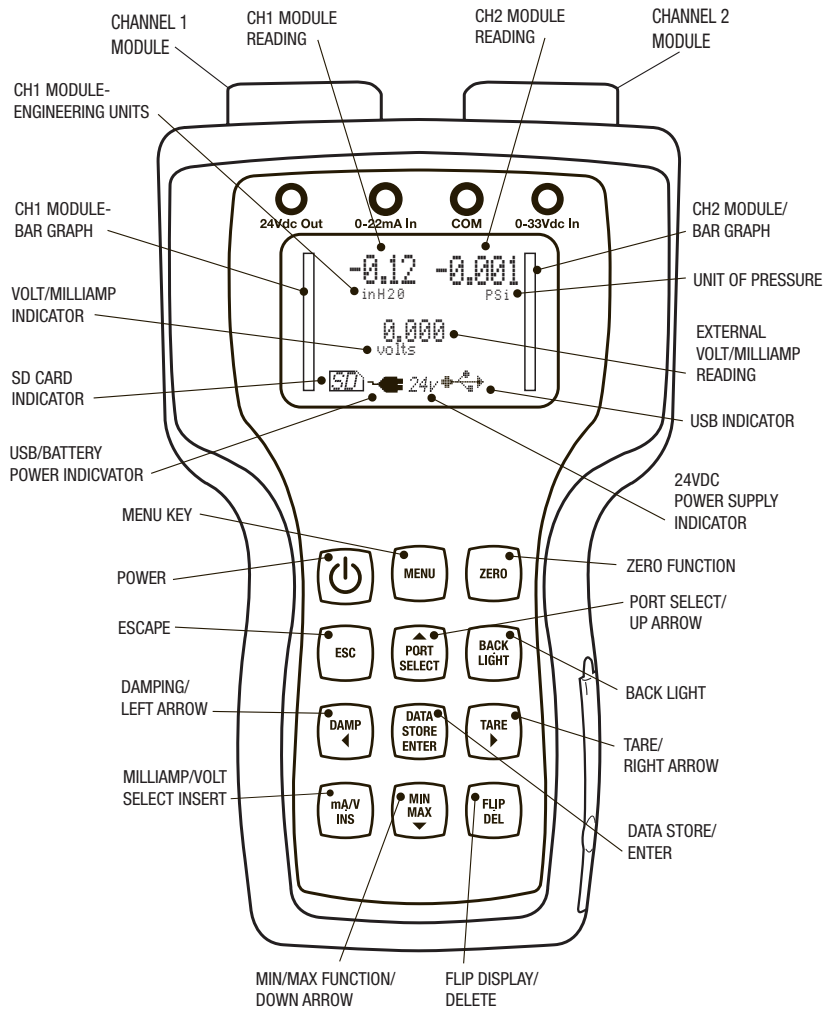

When pressure and or temperature modules are installed and the base unit is powered on, it will briefly display the brand name, data regarding installed modules. Then the HHC will go into measurement mode where it will display up to three values as well as their respective engineering units of measure. The base unit is pre-programmed with twelve units of pressure measurement, four units of temperature measurement, DC voltage 0-30 VDC, DC current 0-20 ma and also allows the user to program a custom pressure unit of measure. In measurement mode, the display will show Battery status, USB connection status, one or two vertical bar graph indicators indicating percentage of full scale pressure and other user interface and warning messages when applicable.

The calibrator is equipped with internal memory capable of storing up to 16,000 records. Datalogs can be transferred to an optional on board SD memory card to clear internal memory and allow further data collection. Datalogs can be transferred to a PC from the SD card and are presented in .csv files which can be opened by Microsoft Excel software.

The operator can program several parameters in the calibrator which are further detailed in this manual. Programmable parameters include:

- Date and time
- Owner name
- Auto off time
- Port selection
- Select Voltage (v) or current (mA) monitoring
- Enable/Disable 24VDC power supply
- Zero modules
- Tare
- Damping
- Percent error function
- Engineering units select
- User defined unit of measure
- Dual sensor mode
- Pressure or Temperature switch test mode
- Calibration of base unit
- Module calibration
- Datalogging via USB
- Datalogging to internal memory
- Transfer datalog to SD card

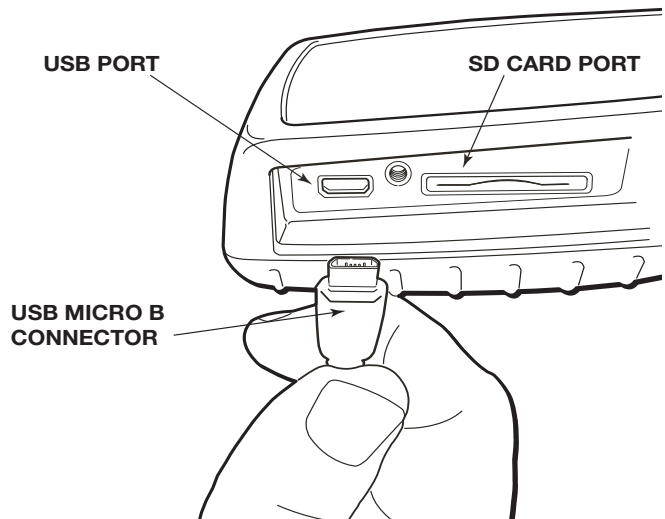

HOW TO OBTAIN PROGRAMMING PASSCODES

Owner name and base unit calibration functions are password protected. The passwords may be obtained by contacting the factory or downloading the "HHC Secure" application from the web site. "HHC Secure" will generate the HHC's unique pass codes based on user input of the base unit serial number. Make a note of these pass codes

Owner Pass code _____

Calibration pass code _____

QUICK-SELECT MODULE OVERVIEW

Quick-select modules are available for measuring a wide variety of pressure and temperature ranges. They can be "hot swapped" within the base unit while it is powered on without causing any damage to the base unit or the module. "Hot Swap" refers to installing or removing modules while the base unit is powered on. The base unit will recognize the module and display the unit of measure in which the module was originally calibrated and labeled. Quick-Select pressure modules are available in accuracies from $\pm 0.1\%$ to $\pm 0.025\%$ of span.

**QUICK-SELECT MODULE
OVERVIEW CONT.**

Quick-Select modules when installed in the base unit are referred to as Channel 1 and Channel 2. Channel 1 is always the module on the left side of the calibrator when it is held upright with modules at the top of the calibrator and the LCD display facing the operator. Channel 2 is on the right side when the base unit is held in the same position.

AM2-1 pressure modules are low pressure measurement devices based on micro machined silicon variable capacitance sensors. They are intended for use with clean dry, nonconductive, non-corrosive gases. They are available in ranges from 0.25 to 200 inches of water column and can be configured to provide differential, gauge or compound readings.

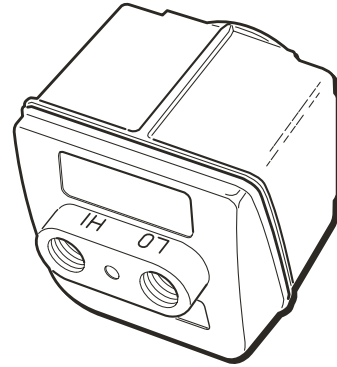

AM2-2 are high pressure measurement devices. They are single-port modules based on sensors capable of measuring gauge, absolute, compound or vacuum with ranges spanning from vacuum to 5 psi to 10,000 psi. All wetted parts are 316 stainless steel (except for 10k psi module which has 17-4ph stainless steel) and are intended for use with any pressure medium compatible with stainless steel.

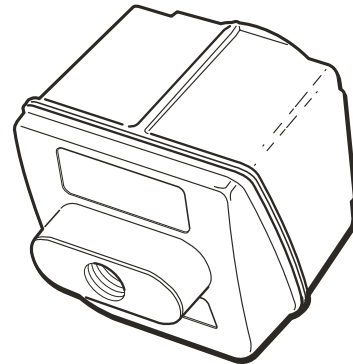

AM2-RT1 and RT2 modules are RTD temperature measurement modules compatible with Pt100, Pt1000, Ni120, Cu10, and up to six user programmable resistance curves. Measurements can be displayed in degrees Fahrenheit, Celsius, Kelvin, Rankin or ohms. The setup menu allows the operator to choose configurations for 2, 3 or 4 wire RTD probes. In addition, the setup menu also allows selection of 1, 0.1, 0.01 or 0.001 decimals of resolution. Accuracy specifications are detailed in the data sheet.

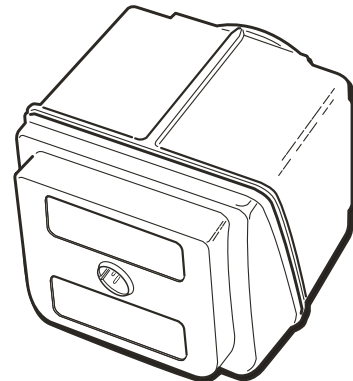

**QUICK-SELECT MODULE
OVERVIEW CONT.**

AM2-TC1 temperature modules read types J, K, T, E, R, S, B and N thermocouples and display the measurement in units of degrees Fahrenheit, Celsius, Kelvin, Rankin or millivolts.

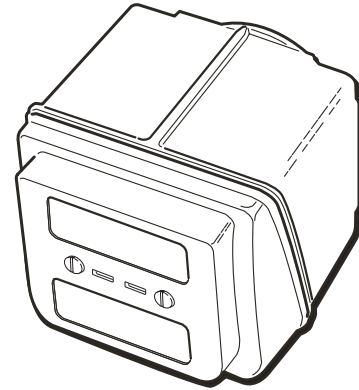

System protection modules AM2-XS are used to protect unused sensor bays in the base unit from moisture or other contamination ingress as well as EMI/RFI interference.

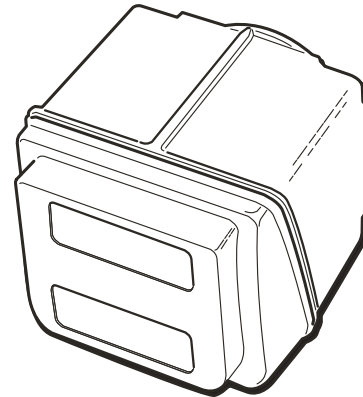

Calibration Module AM2-CM allows the operator to easily make contact with internal connection pins necessary to apply the required voltage levels for recalibration of the HHC base.

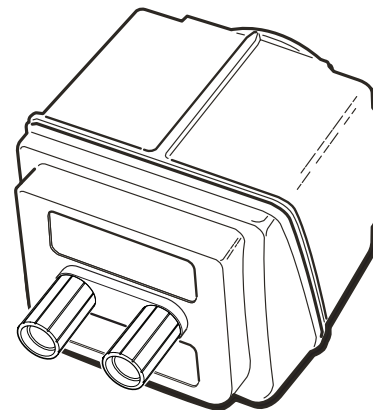

SECTION 7

UNPACKING

Prior to removing the HHC from the packaging material, inspect all cartons for shipping damage. Document any damage evident in the event that a damage claim must be made against the shipper. After inspection, remove the base unit, module(s), manual and any accessories purchased from the packaging material. Retain the packaging for use in returning the HHC to the factory for future calibration or repair.

SECTION 8

STORAGE

Store in an area that is maintained in the temperature range indicated in the storage temperature in the product specification, -4/+158F (-20/+70C). Storage of product in environments that will exceed this temperature limit increases the risk of product damage.

Note: It is recommended that the product not be left in closed cars or truck cabs as temperature damage can easily occur due to drastic temperature changes.

SECTION 9

CLEANING

Clean with a cloth moistened with a warm water/ mild detergent mixture.

SECTION 10

BATTERY INSTALLATION

1. To gain access to the battery compartment, loosen the strap assembly by detaching the Velcro connection and move the strap to the side to allow access to the Phillips head screw on the battery cover door.
2. Open the battery compartment by loosening the Phillips head screw located in the battery compartment door immediately above the product label.
3. Using thumb and forefinger gently lift battery door up and toward the top of the calibrator to remove door.

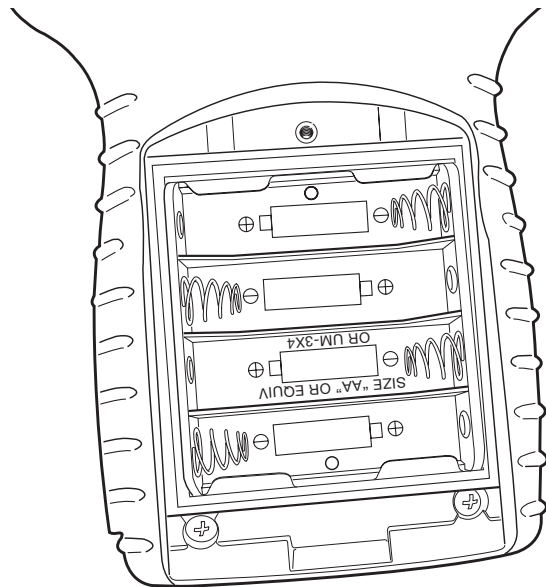

4. Install four new AA Alkaline batteries. (Only Duracell Alkaline part number MN1500 for I.S. units.) Observe polarity markings to install batteries correctly. Never mix old and new batteries.
5. Reinstall battery door. Be sure that the lower latch tab is engaged beneath the clasp hook to ensure proper watertight sealing of the battery compartment.
6. Tighten Phillips head screw in top of cover.
7. Replace strap by tightening strap and secure with Velcro.

Note: if unit will be stored for six months or more be sure to remove batteries before storage to prevent possible battery leakage.

1. Hold the base unit, in one hand, with the keypad side DOWN.
2. Holding the Quick-Select module to be installed in the other hand, align the module with the locking tab up, with the module bay on the base unit.
3. Slide the Quick-Select module into the base unit until the retaining/release tab catches in the square cutout in the module bay of the base unit. This will lock the Quick-Select module into the base unit. Installation is now complete

Note:

If only one module is to be used, install the Quick-Select System Protection module provided. Follow the same procedure to install the system protection module as described above.

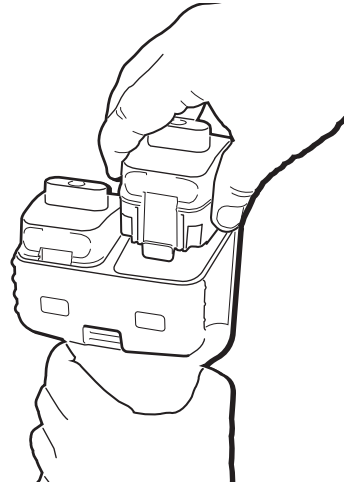

Removal of Quick-Select modules

1. Hold the base unit, in one hand, with the keypad side DOWN.
2. Press the locking tab DOWN to release the module.
3. Grasp the Quick-Select module to be removed in the other hand and gently pull to remove the module. There may be significant resistance to pulling due to O-ring seals on the module needed to maintain water tight integrity.

After the desired Quick-Select module(s) have been installed, power the calibrator on by pressing the green power key.

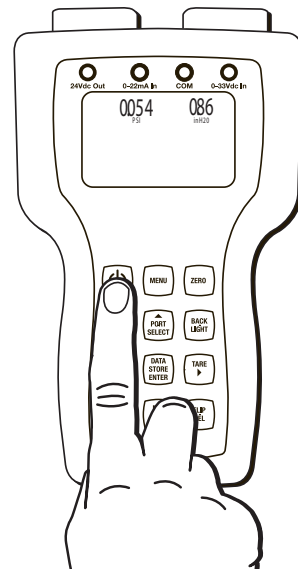

When powering on, the LCD display will briefly indicate the calibrator model number, serial number, owner information and whether it is an intrinsically safe or not intrinsically safe model. If pressure or temperature modules are installed, serial

number, range and calibration data for each module will be briefly displayed before booting up in Measurement Mode.

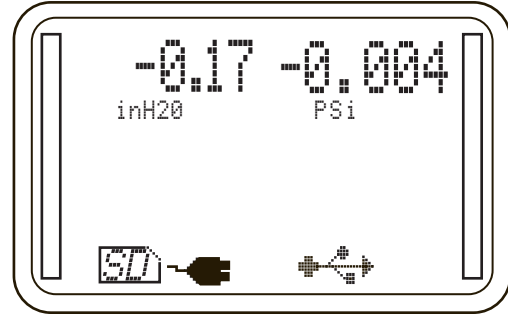

The HHC is now ready for basic pressure or temperature measurement.

Pressure readings from installed modules will be displayed in the engineering unit in which the module was originally calibrated.

Connect the pressure port(s) of the Quick-Select pressure module(s) to be used to the pressure source to be measured. If a gauge pressure measurement is to be made using a low differential pressure Quick-Select pressure module, be sure to connect the pressure to be measured to the high pressure port on the Quick-Select pressure module.

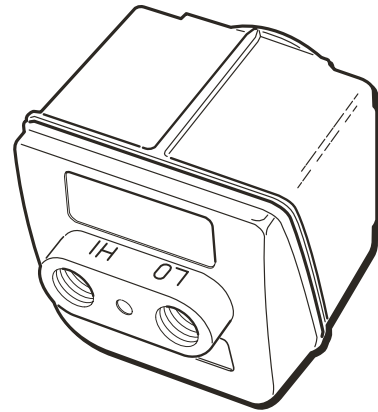



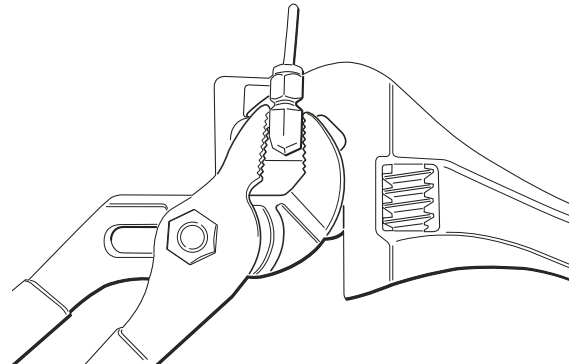





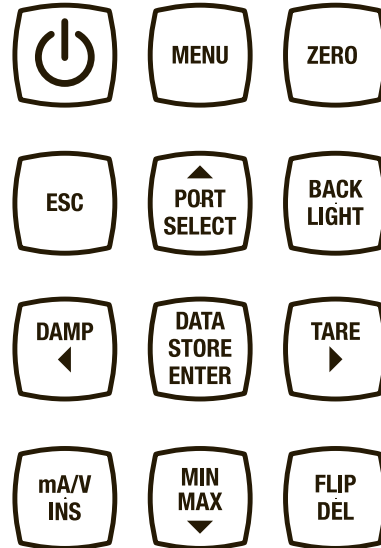



Note: When making connections to pressure ports on Quick-Select modules always use proper tools such as the proper size wrench, slip joint pliers or locking jaw pliers to hold the stainless steel manifold and use a second tool such as a properly sized wrench to tighten the connection. NEVER tighten the fitting by holding it only in the base unit



For temperature measurement, connect the RTD probe to be used to the Switchcraft connector on the interface module then proceed to Section 15j or 15k for instructions on setting up the calibrator for temperature measurement.

The most common functions are accessible by dedicated keys on the keypad. More complex and less often used functions and programmable features are accessible through an easy-to-navigate MENU system. A number of the keys have different functions depending in which mode the HHC is operating. These keys have white and yellow lettering and icons. The white lettering indicates the primary key function. Yellow is the secondary function. A brief overview of the keypad keys and functions follows:



-  Power Key is used to switch the HHC on and off.
-  Used to activate the tare function on installed Quick-Select modules when in Measurement Mode. In MENU Mode used as RIGHT ARROW key.
-  The MENU key is used to enter and exit the programming MENU
-  To activate measurement of milliamps or DC voltage in Measurement Mode.
-  To Zero installed Quick-Select Pressure modules
-  To display Minimum and Maximum measured values in Measurement Mode for selected channels. In MENU Mode, it is used to increment a selected parameter DOWN once per press.
-  Escape Key to go back one level when in MENU Mode or to escape any special display mode. Also aborts auto datalogging.
-  To select installed modules to apply various functions. In MENU Mode, to increment a selected parameter up once per press.
-  To rotate LCD display 180° in Measurement Mode. In Programming Mode to zero numeric characters or change alpha characters to a blank space.
-  To switch back light on and off.
-  To adjust damping level of installed module(s) in Measurement Mode. In MENU Mode it is used as a LEFT ARROW key.
-  Multi-function key. In Manual Datalog Mode, stores one data point of value presently shown on the display. When in Automatic Datalog Mode will begin or end auto logging at the programmed interval. When in programming mode, it is used as the Enter key to save selected parameters.

SECTION 14 a.

ESCFUNCTION

During any programming operation pressing the ESC key will cause the HHC to exit any special display mode or, step back one programming level if in Programming Mode.

SECTION 14 b.

PORT SELECT FUNCTION

PORT SELECT function is used in several programming applications including zero, min/max, tare and damping. This allows the user to choose between installed modules to which an action is to be performed. PORT SELECT is enabled following the initialization of a desired function such as zero. The selected module(s) will be indicated by having a rectangular box surrounding the measurement indication. Pressing the PORT SELECT key repeatedly will allow the user to select the Channel 1, Channel 2 or both channels if applicable. When desired channel (s) are selected the ENTER key is pressed to finalize the selection.

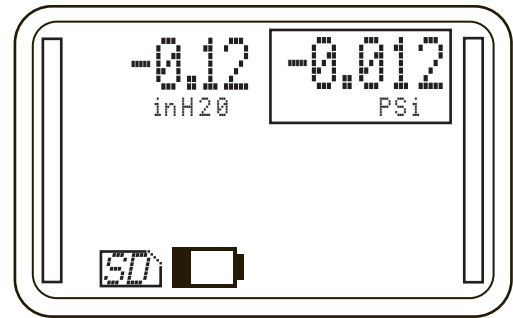

SECTION 14 c.

DATA STORAGE FUNCTION

The default Data Storage mode is manual and is described in section 14g and 15f. The HHC is capable of storing pressure, temperature, voltage or current data for any combination of installed modules, voltage or current inputs that are active, up to three simultaneous data points. Each data record will include a time stamp and up to three measurement values. Headers in the Datalog report label columns with date, user-programmable module description (default values are Channel 1, Channel 2, Ext.) and the engineering unit of measure. Up to 16,000 records can be recorded. Data records are grouped in Datalogs which can be manually initiated or automatically logged at user definable time intervals between 100 milliseconds and 24 hours.

SECTION 14 d.

ZERO FUNCTION

Utilized to remove zero offset, up to 10% of full scale range, when zero pressure is applied.

1. Press the ZERO key. PORT SELECT MENU is entered with the Channel 1 module selected.
2. Use the PORT SELECT key to select Channel 1, Channel 2 or both Channels.
3. Press ENTER to zero the selected module or modules, or press ESC to cancel and return to Measurement Mode

A module must be installed in the HHC base unit to be zeroed. Additionally, it must be a pressure module, and must be within 10% of full scale of its factory programmed zero.

In the event an attempt is made to zero a module that is absent, or which is not a pressure module a warning will be displayed in the notice area stating:

“CH(X) not a pressure mod”.

In the event an attempt is made to zero a module that is more than 10% of full scale from its factory programmed zero, a warning will be displayed in the notice area stating:

“CH(X) zero out of bounds”

SECTION 14 e.

BACK LIGHT FUNCTION

Press the Back Light key to toggle the light on/off. A user programmable back light auto off timer can be used to preserve battery life. Press any key to reset the backlight auto off timer.

The Damping Function stabilizes a measured pressure signal. When damping is activated, the value displayed, saved to a Datalog or transmitted to a journal (eg. To HyperTerminal) is a filtered value. The filtering is programmable to 16 incremental levels, allowing the damping function to be tailored to the specific requirements of most any application. The default damping level is 1. As the damping level is increased, additional electronic filtering is applied and the response time is slowed. Values are displayed on the HHC screen, and recorded by Datalogging at the fastest update rate between 100 and 300 milliseconds, based on how many inputs are active. As damping level is increased the update time increases approximately 100 milliseconds per damping level. With a single pressure module installed and damping set to maximum level 16 the display output can lag by up to 1.6 seconds from the actual process pressure. If two modules are installed and or voltage/current monitoring is active the system display and Datalog values lag will also increase. The longest display lag with two pressure modules programmed for maximum damping and the voltage/current monitor active is 4.8 seconds.

Set up of Damping Function

When in Measurement Mode:

1. Press DAMP key.
2. Press PORT SELECT key to choose Channel 1, Channel 2, or both modules.
3. Press RIGHT ARROW and LEFT ARROW to move cursor to desired damping level (16 possible positions).

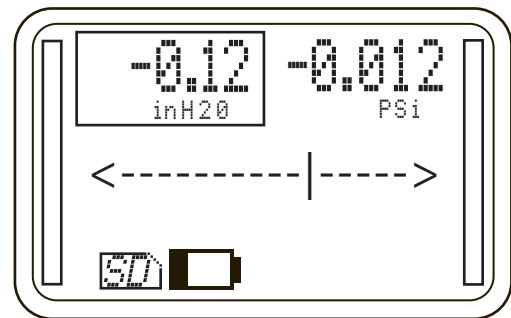

4. Press ENTER to save the value and activate damping.

Once established in the set up MENU the damping process may be enabled or disabled through the use of the DAMP key on the keypad. To activate/deactivate the damping function:

1. Press the DAMP key on the keyboard.
2. Press PORT SELECT key to choose Channel 1, Channel 2, or both modules.
3. Press ENTER to activate damping. Damping level will be indicated below units of measure.

The HHC has two Datalogging modes, Manual and Automatic. Manual mode is the default. Automatic Datalog mode is described in MENU programmable features section 15f.

The first time the DATA STORE key is pressed following power up of the HHC, a new Datalog file will be created. The Datalog column headers will be labeled with date, user programmable module description (default values are Channel 1, Channel 2, Ext.) and the engineering unit of measure. Programming channel and tag names are covered in the MENU driven Datalogging set up section 15f. The first row of the Datalog will be populated with measurements as shown on the LCD display. Subsequent presses of the DATA STORE key will create manual data records into this initial Datalog.

SECTION 14 g.

**MANUAL DATALOG FUNCTION
CONT.**

To close a Datalog and prepare the HHC to begin a new Datalog press the ESC key. The next press of the DATA STORE key will begin a new Datalog and will continue to record data in the new log with every subsequent press of the key.

Up to 64 individual logs can be stored in the on board memory with a total of 16,000 individual records.

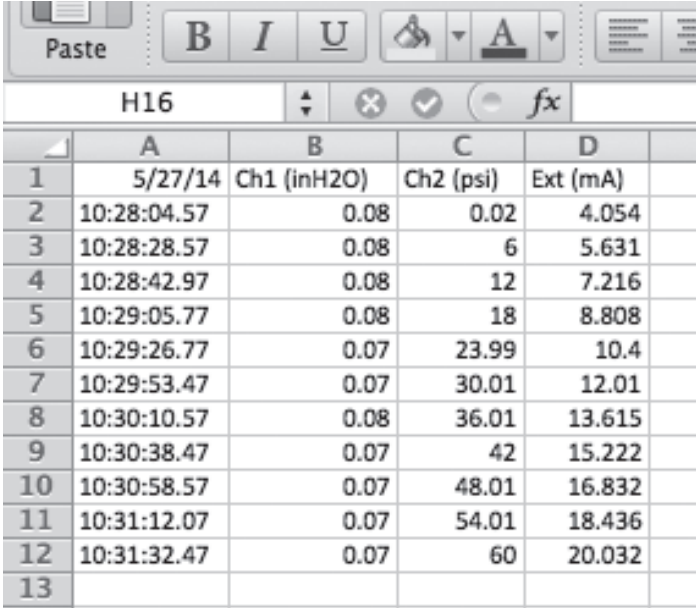

H16				
	A	B	C	D
1	5/27/14	Ch1 (inH2O)	Ch2 (psi)	Ext (mA)
2	10:28:04.57	0.08	0.02	4.054
3	10:28:28.57	0.08	6	5.631
4	10:28:42.97	0.08	12	7.216
5	10:29:05.77	0.08	18	8.808
6	10:29:26.77	0.07	23.99	10.4
7	10:29:53.47	0.07	30.01	12.01
8	10:30:10.57	0.08	36.01	13.615
9	10:30:38.47	0.07	42	15.222
10	10:30:58.57	0.07	48.01	16.832
11	10:31:12.07	0.07	54.01	18.436
12	10:31:32.47	0.07	60	20.032
13				

SECTION 14 h.

TARE FUNCTION

The HHC has the ability to Tare (subtract an operator selected value) from the displayed pressure measurement value of either one or two installed Quick-Select modules. This function is applicable to pressure measurements only. This is most commonly required in applications where a pressure pre-load, such as in a weighing application, must be subtracted from the displayed pressure measurement. If the HHC is being used with two Quick-Select modules, independent tare values can be entered for each of the pressure modules. When tare function is active bar graph displays will indicate actual percentage of full scale pressure not the tare value. When the HHC is in tare mode the word "tare" will appear below the engineering units.

There are two methods to select a tare value, automatic and manual. Automatic Tare Mode will subtract the actual pressure applied to the module at the time tare function is activated. Manual Tare Mode allows the operator to enter a pressure value to be subtracted from the actual pressure applied to the module. Automatic tare is the default condition. If Manual Tare Mode is desired go to the section named Program Manual Tare Value below the next section.

Activate Tare Mode

To activate either Automatic or Manual tare Mode.

When HHC is in Measurement Mode

Press TARE key

Press PORT SELECT key repeatedly to select Channel 1, Channel 2, or both active pressure modules

Press ENTER

Selected modules are now in Tare Mode. The value displayed is equal to the actual applied pressure less the tare value.

When TARE function is active the word "Tare" will be displayed below the engineering units.

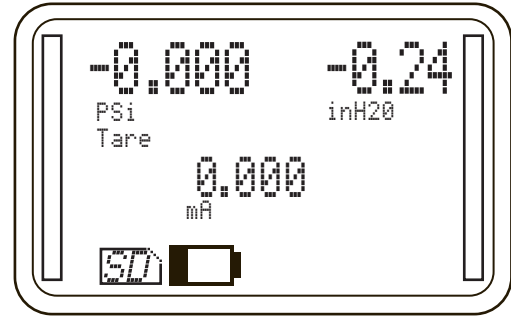
**Exit Tare Mode**

Press TARE key

Press PORT SELECT key repeatedly to select Channel 1, Channel 2, or both active pressure modules

Press ENTER

Selected modules are now in Measurement Mode without a tare value.

Program Manual Tare Value:

Press MENU key

Press DOWN or UP ARROW key to highlight "Modes..."

Press ENTER

Press DOWN or UP ARROW key to highlight "Tare..."

Press ENTER

Press DOWN or UP ARROW key to highlight "CH1 auto/manual or CH2 auto/manual"

Press ENTER

Press DOWN or UP ARROW key to highlight Auto or Manual

Select "manual" and press "ENTER" to advance to "Enter CHx tare"



Press left or RIGHT ARROW key to select digit

Press UP and DOWN ARROW keys to advance numeric values

When desired tare value is displayed

Press ENTER

The HHC will enter Measurement Mode.

Select Automatic Tare Mode

Note that the default tare mode is Automatic. Tare Mode will be reset to automatic when the unit is turned off. It is unnecessary to program automatic tare mode unless manual mode was used in the same session.

Press MENU key

Press DOWN or UP ARROW key to highlight "Modes..."

Press ENTER

Press DOWN or UP ARROW key to highlight "Tare..."

Press ENTER

Press DOWN or UP ARROW key to highlight "CH1 auto/manual or CH2 auto/manual"

Press ENTER

Press DOWN or UP ARROW key to highlight Auto or Manual

Select "auto" then press ENTER to exit back to Measurement Mode

SECTION 14 i.

mA/V FUNCTION

The HHC has the capability to monitor either DC milliamp current 0-22 mA or DC voltage 0-33 Vdc. Use of this feature requires connection to the voltage or current source via the 4mm "Banana Jacks" located above the units LCD. Note that this calibrator can monitor only one parameter, either voltage or current, at a time.

To monitor voltage connect the negative lead of the voltage source to the socket labeled "COM" with a black ring surrounding the socket. Connect the positive lead of the voltage source to the red ringed terminal labeled "0-33Vdc In".

To monitor current connect the negative lead to the black ringed terminal labeled "COM. Connect the positive current source to the red ringed terminal labeled "0-22mA In".

Devices under test may be powered by an external power source, or by the 24 Vdc power supply built into standard (non-intrinsically safe) HHC base units. See wiring diagrams in section 14j.

Press the mA/V key to activate voltage and current monitoring. Press again to rotate through Volts, mA and pressure only measurement.

SECTION 14 j.

WIRING DIAGRAMS

4/20 TRANSMITTER HOOK UP USING, INTERNAL SUPPLY

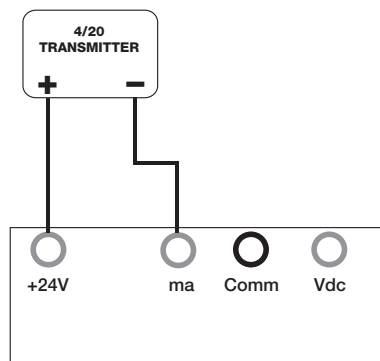

V OUT TRANSDUCER HOOK UP USING, INTERNAL SUPPLY

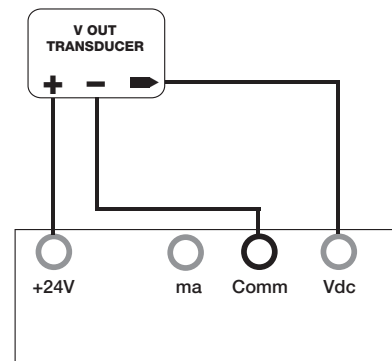

4/20 TRANSMITTER HOOK UP USING, EXTERNAL SUPPLY

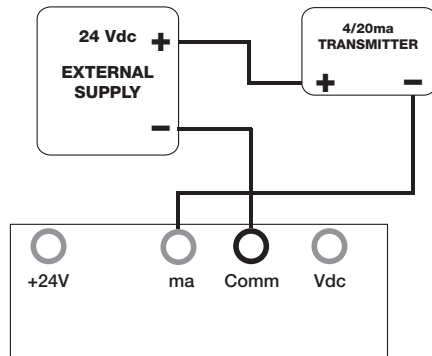

V OUT TRANSDUCER HOOK UP USING, EXTERNAL SUPPLY

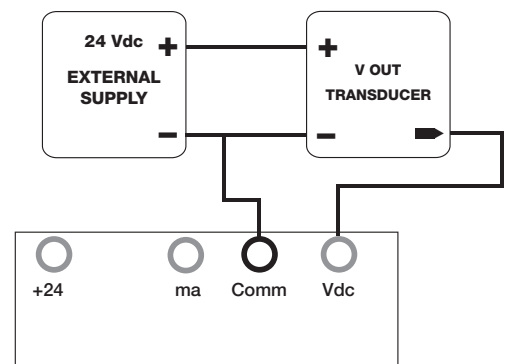

Note that you can use a normally closed switch as well

SWITCH HOOKUP USING INTERNAL SUPPLY SWITCH NORMALLY OPEN

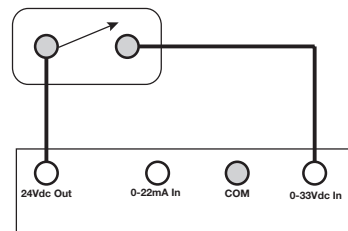

EXTERNAL 24 VDC SUPPLY SWITCH HOOKUP USING INTERNAL SUPPLY SWITCH NORMALLY OPEN

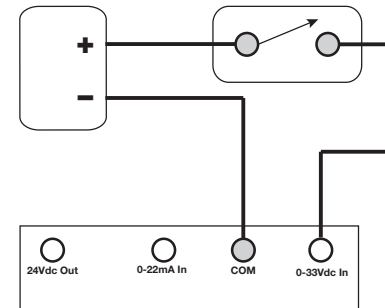

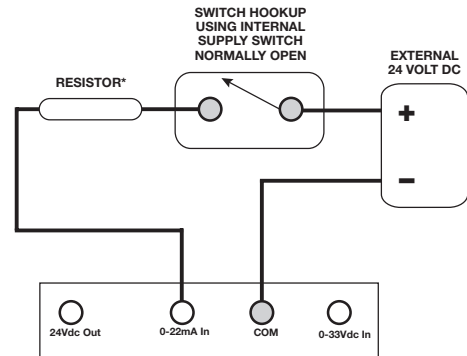

*Resistor should be sized to allow current as follows:
 $2\text{ mA} < I < 36\text{ mA}$, $2\text{ mA} \approx 12\text{ k}\Omega$, $35\text{ mA} \approx 686\Omega$

24 VDC POWER SUPPLY ENABLE AND DISABLE

Enable and Disable 24 Vdc Power Supply (Non-intrinsically safe version only)

Press MENU key
 Press DOWN or UP ARROW key to highlight "24v Loop Supply On/Off"
 Press ENTER

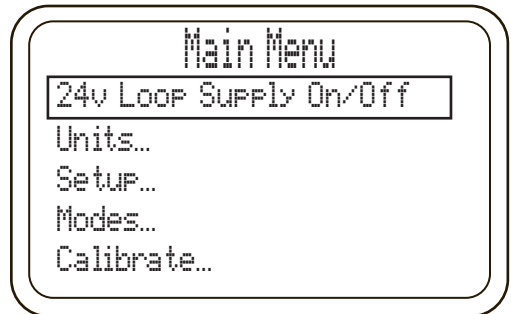

HHC will return to Measurement Mode and "24v" is shown on center bottom of display to indicate power supply is activated.

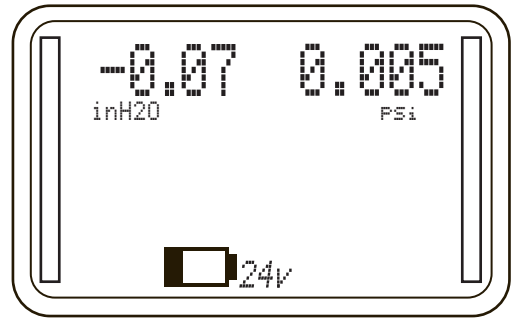

To Disable 24V Power Supply

Press MENU key
 Press DOWN or UP ARROW key to highlight "24v Loop Supply On/Off"
 Press ENTER

HHC will return to Measurement Mode, "24v" has been removed from the display. Power supply is now deactivated.

Note: In power supply off condition leakage of approximately 1.0 V and 0.03 mA will be measurable, this voltage and current is not adequate to drive most loads.

Loop Power Overload and Reset

The 24v loop supply is rated to source up to 35 mA of current. Overload protection is activated at approximately 54 mA. If the load current exceeds this value, the overload protection function deactivates the loop supply and will switch off the "24V" icon on the LCD display. In the event of an overload the following Error message will be displayed:



SECTION 14 k.

24 VDC POWER SUPPLY ENABLE AND DISABLE



Remove the excessive load from the circuit and attempt to activate the 24v loop power supply via the MENU as described above.

If the excessive load is not removed from the circuit upon activation, the loop supply will be disabled and the following warning message will be displayed

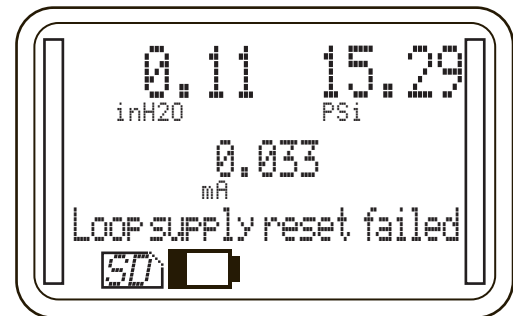

Note: A direct short between 24Vdc out and COM terminals will cause complete shut down of the base unit. Remove shorted leads and power the HHC on with the power key. Base unit will not be damaged, however warning messages will not be displayed.

If the user correctly removes the excessive load and resets the loop supply successfully via the MENU 24v loop supply indicator turns back on and normal function is restored.



SECTION 14 l.

MIN/MAX FUNCTION

Display the minimum and maximum pressure or temperature readings measured by the installed modules. This function can be performed once the HHC has been powered on, module "hot swapped" into the HHC, or values that were zeroed.

Min /Max function is actively updating the display continuously once it is activated.

To enter Min/Max mode

Press Min/Max key

Press PORT SELECT key to select Channel 1, Channel 2, or both modules.

Press the ENTER key

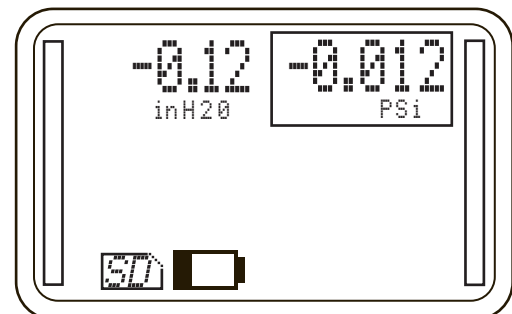

SECTION 14 I.

MIN/MAX FUNCTION CONT.

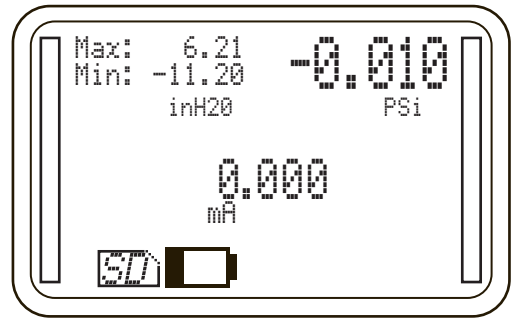

To clear active Min/Max measurements press the ZERO key.

To exit Min/Max mode completely press the ESC key.

Note: Datalogs recorded while in Min/Max Mode will record the real time pressure measurements at the time of writing to the Datalog, not the min/max values. If minimum and maximum values occur between log entries, the data will NOT be included in the Datalog.



SECTION 15

MENU MODE FUNCTIONS

MENU Mode is where more sophisticated HHC functions are programmed. Not all users will need to access all features available in MENU Mode. Some features, such as setting user name, date and time will be done once or twice in the life of the calibrator. Others such as transferring Datalogs may be used several times per day. There are several safeguards built into the HHC to prevent a user from accidentally changing parameters or deleting information. **Be aware that there are functions such as erasing Datalog memory that are permanent and cannot be restored once they are completed.**

SECTION 15 a.

MENU MODE GENERAL KEY FUNCTIONS

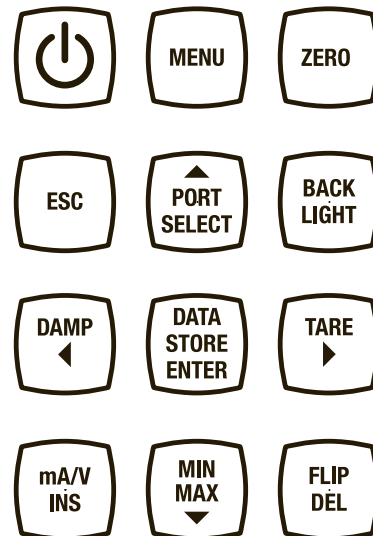

MENU key

Enter MENU Mode by pressing the MENU key

Exit MENU Mode directly to Measurement Mode at any time by pressing the MENU key

ESC function

During any MENU operation pressing the ESC key will prompt the unit to step back one programming level.

ENTER function

The DATA STORE/ENTER key is a dual function key. In MENU Mode this key is used to acknowledge and save a parameter being programmed or selected.

UP and DOWN ARROW keys

PORT SELECT/UP ARROW and MIN/MAX/DOWN ARROW keys are dual function keys. When in Menu Mode these keys are used

SECTION 15 a.

MENU MODE GENERAL KEY FUNCTIONS CONT.

to move the selection box in a MENU UP or DOWN, and are also used to scroll through programmable parameters such as alpha numeric characters when programming names.

LEFT and RIGHT ARROW Keys

DAMP/LEFT ARROW and TARE/RIGHT ARROW keys are dual function keys which are used in MENU Mode to move the cursor to the right or left.

FLIP/DEL key when in Programming Mode is used to zero a numeric character or advance an alpha character to a blank space.

Upon entering MENU Mode the display will show "Main Menu" and a list of MENU selections will appear below.

Use the UP and DOWN ARROWS to scroll to the desired parameter then press ENTER to begin working with that parameter.

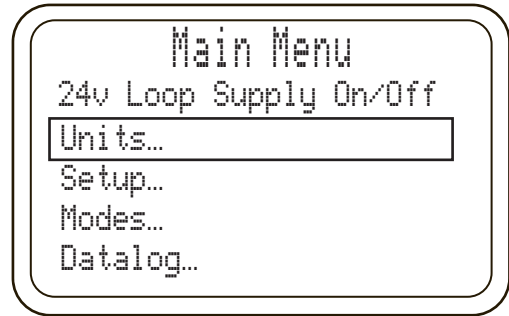

SECTION 15 b.

BASE UNIT SET UP

The HHC allows the user to set up several parameters which remain stored in memory for the life of the base unit, or need to be reprogrammed very infrequently. These parameters include date, time of day, Owner, and auto off timers.

Note: Date and time will need to be reprogrammed following factory replacement of the real time clock battery approximately once every 6 years.



SECTION 15 b. i.

Programming Date & Time

Programming Date and Time

Note: time is entered in 24 hour military format.

Press MENU key

Press DOWN or UP ARROW key to highlight "Setup..."

Press ENTER

Press DOWN or UP ARROW key to highlight "System"

Press ENTER

Press DOWN or UP ARROW key to highlight "Date/Time..."

Press ENTER



Press LEFT or RIGHT ARROW to select numeric position for month, date, year, hour, minute and second

Press UP or DOWN ARROW to change numeric values

When correct MM/DD/YY and HH:MM:SS values are displayed press ENTER to accept and save

The HHC will save and exit to Measurement Mode.

Note: if an inappropriate date or time value is used, the HHC will display an error message "Date Set Failed" and prompt the user to retry or abort the attempt to program.



SECTION 15 b. ii.

Programming Owner Name

Programming Owner Name (15 Characters max)

Press MENU key
Press DOWN or UP ARROW key to highlight "Setup..."
Press ENTER
Press DOWN or UP ARROW key to highlight "System"
Press ENTER
Press DOWN or UP ARROW key to highlight "Owner..."
Press ENTER
Owner Password screen appears. If the Owner Password is not known, see section 5 to obtain owners password.



Press left and RIGHT ARROWs to position cursor beneath desired character
Press UP and DOWN ARROWs to increment numeric characters
When the password is correct press ENTER
"Enter Owner name" screen appears

Note: If the incorrect password is entered, the HHC display will show a message "Bad Owner PW", and the user will be asked to Retry or Abort.

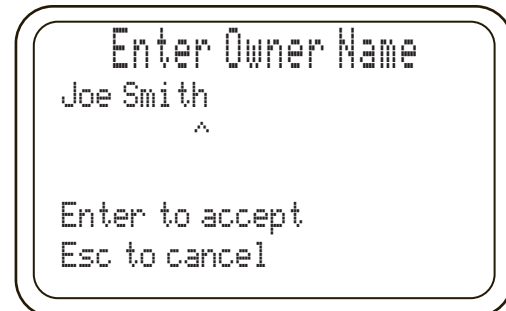

Press LEFT and RIGHT ARROWs to position cursor beneath desired character
Press UP and DOWN ARROWs to increment alpha and numeric characters
When the Owner name is correct press ENTER
The HHC will save and exit to Measurement Mode.

SECTION 15 b. iii

Program Auto Off Timers

The HHC has two programmable auto off timers designed to maximize battery life. The "Power Off" timer will shut down the HHC base unit completely after a user selected time. The "Backlight Off" timer controls the backlight function only. It is possible to have two different times programmed for these features. Selecting the option "Never" for either function will disable the timer altogether and the user must manually switch the base unit and backlight on/off by pressing the proper key.

Note: When the HHC base unit is powered via the USB port or is auto datalogging, auto off timers are both disabled.

Program Auto Off Timers

Press MENU key
Use DOWN or UP ARROW to highlight "Setup"
Press ENTER
Use DOWN or UP ARROW to highlight "System..."



SECTION 15 b. iii

Program Auto Off Timers Cont.

Press ENTER
Use DOWN or UP ARROW to highlight "Auto off timer..."
Press ENTER
Use DOWN or UP ARROW to highlight "Power off"..
OR
Use DOWN or UP ARROW to highlight "Backlight off"...

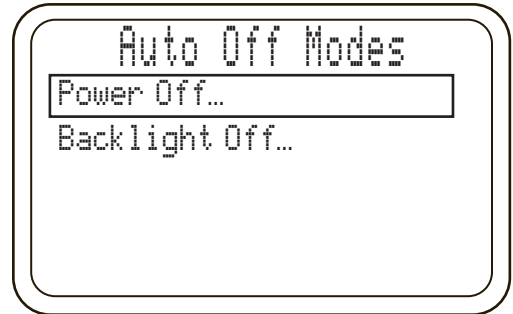

Press ENTER
Use DOWN or UP ARROW to highlight desired time in minutes or "Never"



Press ENTER
HHC will return to Measurement Mode with values being saved

SECTION 15 c.

ENGINEERING UNITS SELECTION

Select Engineering Units

Press MENU key
Press DOWN or UP ARROW key to highlight "Units..."
Press ENTER
Press DOWN or UP ARROW key to highlight "Select Units"
Press ENTER
Press DOWN or UP ARROW key to highlight "Channel 1 Module", "Channel 2 Module"
Press ENTER
Press DOWN or UP ARROW key to highlight desired engineering unit

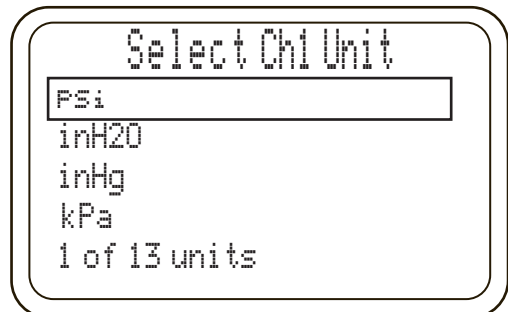

Press Enter to select unit and exit to Measurement Mode.

Note: The HHC has 99,999 counts of resolution. The display is capable of displaying five digits up to 99,999. Selecting engineering units which approach 99,999 counts of resolution could result in the least significant digits to appear unstable.

Note: Units of measure whose full scale value exceeds 99,999 will not be available to be selected.



SECTION 15 d.

H₂O TEMPERATURE CONVERSION SELECTION

If the user selects an engineering unit which references water column pressure, they can select a water temperature to factor into the conversion. The pressure generated by a column of water will vary with the temperature of the water. As there are industry standard temperatures used as conversion factors when calibrating pressure measurement devices in terms of the height of a column of water, the HHC uses three(3) conversion factors, (20°C <factory default>, 60°F and 4°C).

The user may select one to use with the water column based pressure units.

Temperature Selection for H2O Conversion Factor

To select the reference water temperature:

Press MENU key

Press DOWN or UP ARROW key to highlight "Units..."

Press ENTER

Press DOWN or UP ARROW key to highlight "H2O ref temp"

Press ENTER

Press DOWN or UP ARROW key to highlight "4 Deg C", "60 Deg F" or "20 Deg C"



Press ENTER to select temperature and exit to Measurement Mode.

SECTION 15 e.

PROGRAMMING USER DEFINED UNITS OF MEASURE



If one of the preprogrammed engineering units of pressure measure is not acceptable, the user can program the HHC to read in a user defined unit.

Note: That the conversion factor programmed is always programmed in relation to PSI engineering units regardless of the pressure units that the pressure module is calibrated in. The conversion factor is 1.0 PSI= X custom units.

Programming User defined Units of Measure for Pressure Modules

Press MENU key

Press DOWN or UP ARROW key to highlight "Units..."

Press ENTER

Press DOWN or UP ARROW key to highlight "User Units"

Press ENTER

Press UP and DOWN keys to select "Name" or "Conversion Factor"

Programming Unit of measure Name (up to 6 characters)

Select "Name"

Press ENTER

"Enter Unit Name" screen appears

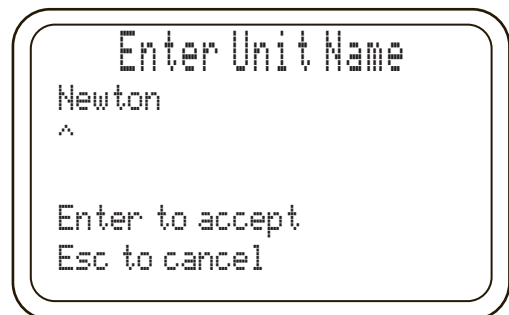

SECTION 15 e.

**PROGRAMMING USER DEFINED
UNIT OF MEASURE CONT.**



Press left and RIGHT ARROWS to position cursor beneath desired character
Press UP and DOWN ARROWS to increment alpha and numeric characters

When the Unit name is correct press ENTER

HHC will return to "User Units" screen

Note: Unit of Measure names are limited to six characters.

Programming User Units Conversion Factor

Note: The User Units Conversion Factor is always programmed in relation to psi engineering units regardless of the pressure units that the pressure module is calibrated in. The conversion factor is 1.0 PSI= X custom units.

From the "User Units" Screen

Press the UP and DOWN ARROW keys to select "Conversion Factor"

Press ENTER

"Enter Conversion" screen appears



Press left and RIGHT ARROWS to position cursor beneath desired numeric character.

Press UP and DOWN ARROWS to scroll numeric values.

When desired numeric value is displayed in proper decimal position press ENTER to accept.

HHC will save the value and exit to Measurement Mode.

The user defined unit of measure name will now appear in the list of engineering units listed under the Engineering Units programming MENU and can be applied to any active pressure module installed in the HHC.

SECTION 15 f.

DATALOGSETUP

The HHC includes manual and automatic logging. Manual logging is performed by pressing the DATA STORE key. This action will save the measured values presently read in a Datalog in the internal memory of the HHC. Automatic Datalogging allows the user to program a timed interval between measurements which will be saved in one Datalog in the internal memory.

Up to 64 individual logs can be stored in the on board memory and a total of 16,000 individual records.

Default Datalog tag names are as follows:

Datalog name XXMMDDYY, XX= sequential number of Datalog (01-64). Datalog name is generated by the HHC and is not user programmable.

The default channel tag names are:

Channel 1 = CH1

Channel 2 = CH2

Voltage or current monitor = Ext

Program Channel Tag Names

Program Channel Tag Names (up to 7 characters)

The default channel names, Channel 1, Channel 2 and Ext can be re-programmed by the user.

Press MENU key
Use DOWN or UP ARROW to highlight Datalog...
Press ENTER
Use DOWN or UP ARROW to highlight Set channel tags.....

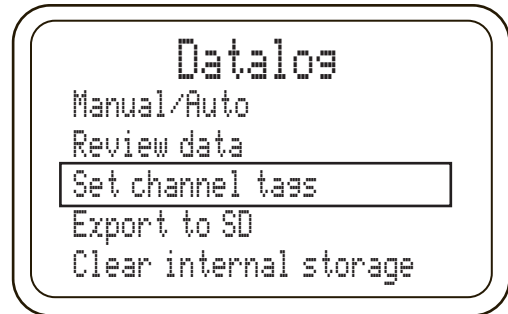

Press ENTER
Use DOWN or UP ARROW to highlight Channel 1, Channel 2 or external input...
Press ENTER
Display will show "Enter CH 1 Tag"

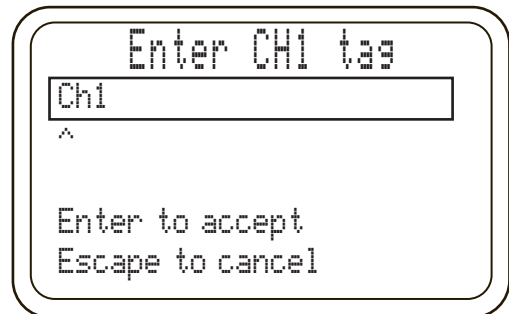

"^" Beneath a character or space indicates which character in the tag name is being configured.

Use the DOWN or UP ARROW to scroll through alpha and numeric characters

Note: Pressing the DEL key will advance the alpha numeric character to the blank space character which is the divider between numeric and lower case alpha characters.

Use the left and RIGHT ARROWS to move the cursor.

When tag name is displayed as desired press ENTER

Display will return to the "Select Channel" MENU

Choose another channel to program or press MENU to exit to Measurement Mode or ESC to move back to the "Datalog" MENU.



Program Auto Datalog Time

Program Auto Datalog Time

Auto Datalogging allows the user to program a Datalogging interval between 0.1 second and 86,400 seconds (24 hours).

Press MENU key
Use DOWN or UP ARROW to highlight "Datalog..."
Press ENTER
Use DOWN or UP ARROW to highlight "Manual/Auto..."
Press ENTER
Use DOWN or UP ARROW to highlight Manual or Auto, select "Auto"..
Press ENTER
Display will show "Set Log Interval"

SECTION 15 f. ii.

**Program Auto Datalog Time
Cont.**

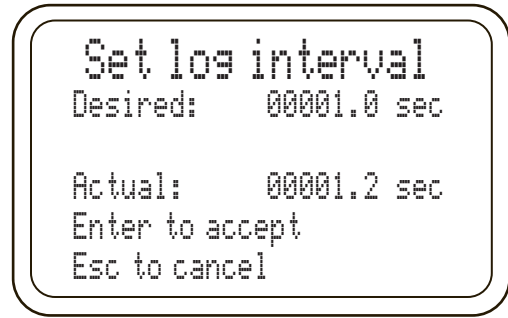

“^”Beneath a digit indicates which character in the time interval name is being configured.

Press UP or DOWN ARROW to scroll through numeric values
Use left or RIGHT ARROW to move cursor to next desired position.

When the desired time interval in seconds is displayed, press ENTER

The HHC will return to Measurement Mode.

NOTE

Note: When programming, the display will show “Desired” interval and “Actual” interval. Actual interval may not match the desired value. The minimum sample rate changes are based on the number of inputs installed in the base unit. The sample rate increase 0.1 seconds per input (0.1, 0.2 or 0.3 seconds). The actual interval must be an even multiple of this value. For example, if there are two pressure modules and a voltage input active, the minimum sample rate is 0.3 seconds or even multiples of 0.3 seconds. If the desired value entered is 0.1 seconds the actual value will remain 0.3 seconds.



SECTION 15 f. iii.

Initiate Auto Datalog

Initiate Automatic Datalog

To initiate an automatic Datalog after programming desired channel tag names and logging interval press DATA STORE key. The display will show a message saying “Auto-logging”

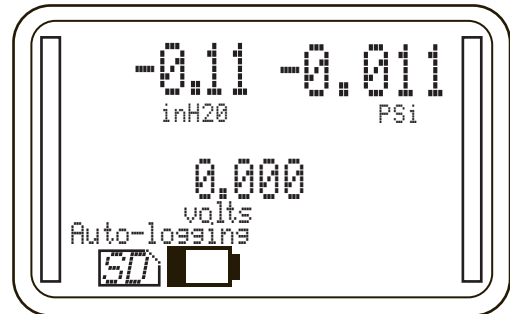

To disable auto logging press either DATA STORE key or ESC key.

SECTION 15 f. iv.

Initiate Manual Datalog

Initiate a Manual Datalog

After programming desired channel tag names

Press MENU key

Use DOWN or UP ARROW to highlight “Datalog...”

Press ENTER

SECTION 15 f. iv.

Initiate Manual Datalog Cont.

Use DOWN or UP ARROW to highlight "Manual/Auto..."
Press ENTER
Use DOWN or UP ARROW to highlight Manual or Auto, select "Manual..."
Press ENTER
Display will return to Measurement Mode.
Press DATA STORE to begin a new manual Datalog.
Display will briefly show "Data point Taken" then will display "Manual log enabled"

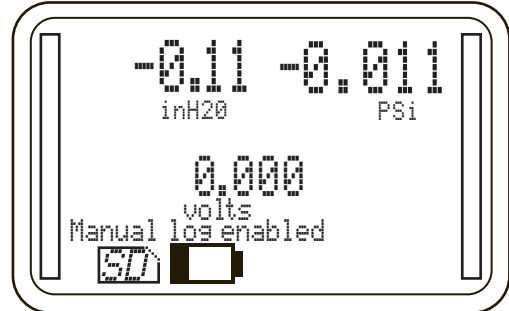

Subsequent presses of DATA STORE will add one new data point for each key press.

To close a manual Datalog press ESC

The next press of Datalog key will begin a new Datalog file.

SECTION 15 f. v.

Review Datalog Data

Datalogs stored on the internal memory can be reviewed on the HHC display.

Review Datalogs

Press MENU key
Use DOWN or UP ARROW to highlight Datalog...
Press ENTER
Press DOWN or UP ARROW to highlight Review data...
Press ENTER
"Select datalog" screen will appear.

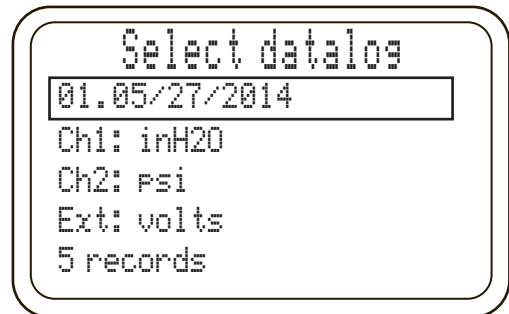

Use up and DOWN ARROWs to scroll through saved Datalogs.
Press ENTER when desired name appears
Review Data screen appears

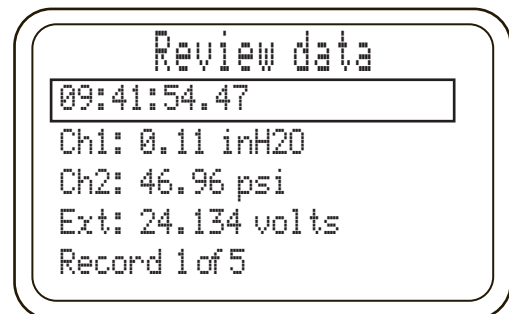

Press DOWN or UP ARROW to review individual data records.
Exit Data review mode completely by pressing MENU.

SECTION 15 f. v.

SECTION 15 f. vi.

Review Datalogs Cont.

Export Datalogs to SD Card

Or

Press ESC to go back to “Select Datalog” screen and choose another log to review.

The HHC contains a slot for a standard SD memory card. When a card is installed Datalogs can be exported to the card in .CSV (Comma Separated Values) files which are able to be read by Microsoft Excel or other spread sheet software. One .CSV file is generated per Datalog.

Datalog file name XXMMDDYY, XX= sequential number of Datalog (01-64). Datalog name is generated by the HHC and is not user programmable.

TO EXPORT DATALOGS

Press MENU key

Use DOWN or UP ARROW to highlight Datalog...

Press ENTER

Press DOWN or UP ARROW to highlight “Export to SD”

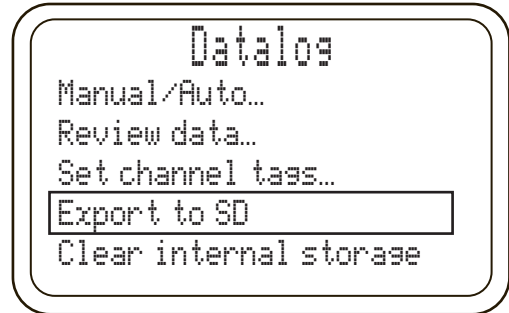

Press ENTER

“Exporting logs” screen will appear and remain on until transfer operation is complete.

When the export process is completed successfully a message reading “Exported logs to SD” will appear briefly before the HHC returns to Measurement Mode.



Datalogs will appear in a folder on the SD card labeled DATALOGS.

If a new or formatted SD card is used the HHC will create the file folder and deposit the logs there.

Note: if an SD card is not installed or if there is a problem writing the Datalog to the SD card a warning message “No SD card present” will be displayed. Check that the SD card is installed properly in the slot and attempt to download again.

WARNING: This command PERMANENTLY DELETES ALL Datalog FILES stored in the internal memory. This process does not effect datalogs transferred to the SD card.

Press MENU key

Use DOWN or UP ARROW to highlight “Datalog...”

Press ENTER

Press DOWN or UP ARROW to highlight “Clear Internal Storage”

Press ENTER

“Delete all logs?” screen will appear



SECTION 15 f. vii

Clear Internal Memory Storage

**Clear Internal Memory Storage
Cont.**



Use DOWN or UP ARROW to highlight Yes or No
 Press ENTER
 Selecting "no" will return to the Datalog MENU
 Selecting "yes" will proceed to "Clearing Logs..." screen.

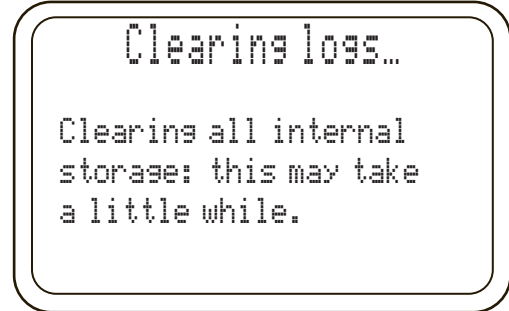

When the operation is complete the HHC will return to Measurement Mode.

SWITCH TESTING FUNCTION



The HHC can be used to test pressure and temperature switches. Onboard firmware provides the ability to verify switch trip point, reset point and to calculate deadband of a pressure switch. The HHC looks for a change of state that produces either 2 volts or a 2 mA change across the corresponding voltage or current input terminals.

Prior to initiating this test procedure the required electrical set up should be configured to provide the necessary signal levels per the wiring diagrams presented in section 14j.

Note: Switch test requires slow changes in process pressure. See damping to minimum setting.

Set up switch test

The operator must program the following parameters before beginning switch testing:

- Measurement Channel (Channel 1, Channel 2)
- Input Signal type (Voltage or current)
- Switch type (Normally open or closed).
- See wiring diagrams in Section 14j

Press MENU key
 Use DOWN or UP ARROW to highlight "Modes..."

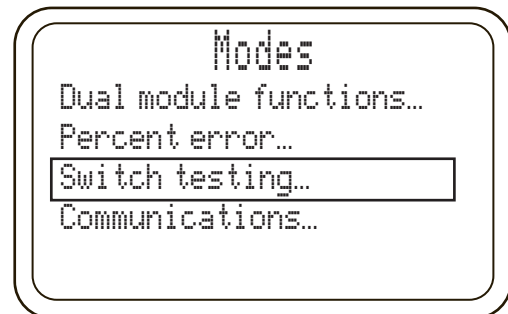

Press ENTER
 Use DOWN or UP ARROW to highlight "Switch testing..."
 Press ENTER

**SWITCH TESTING FUNCTION
CONT.**

Use DOWN or UP ARROW to highlight “Measurement Channel...”
 Press ENTER
 Use DOWN or UP ARROW to highlight “CH1” (Channel 1 module) or “CH2” (Channel 2 module)...
 Press ENTER
 HHC will go back to Switch Testing MENU
 Use DOWN or UP ARROW to highlight “Signal Type...”
 Press ENTER
 Use DOWN or UP ARROW to highlight “Current or Voltage...”
 Press ENTER
 Use DOWN or UP ARROW to highlight “Switch Type...”
 Press ENTER
 Use DOWN or UP ARROW to highlight “Normally Open or Normally Closed...”
 Press ENTER
 Display will briefly display the message “Begin Test” then immediately enter switch test mode.

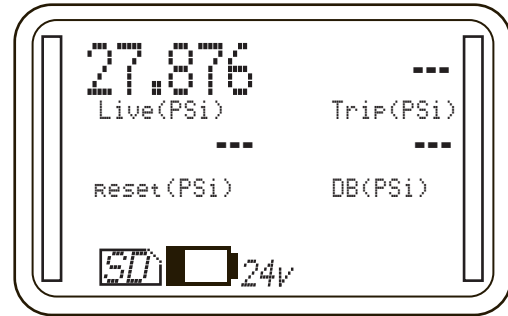

In Switch Test Mode the display will initially show the Live pressure (pressure being applied at that time), and units of measure. The switch trip point, reset point and dead band (DB) will be blank indicated by “---”

Setup is now complete and switch testing can begin. Depending on the options chosen above either apply additional pressure or release pressure slowly.

Note: depending on number of modules installed the update rate will be either 0.2 or 0.3 seconds. A rapid increase or decrease in pressure near the switch setpoint can result in inaccurate readings

When the switch opens or closes the pressure/temperature reading and units of measure will be displayed as “trip” point.

Slowly release or increase pressure (opposite of the action taken in the earlier step) until switch state changes again. This value will be displayed as the “reset” value along with units of measure. The deadband (DB) will also be calculated and displayed. This value is the difference between the trip point and reset point.

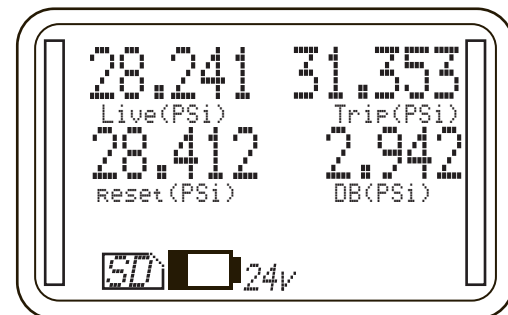

If desired, record the readings displayed on the screen. These values are not included in the manual Datalog.

To reset switch test and maintain the same parameters press the ZERO key to return to initial testing screen.

To exit switch test mode press ESC

To enter Main MENU Programming Mode press MENU.

PERCENT (%) ERROR FUNCTION

The Percent Error Function allows the user to display the output from a device under test in terms of percent error of the full scale range of that device. This function applies to the calibration of both temperature and pressure devices. Percent error mode eliminates the need for manual calculations to determine the level of accuracy of the device under test.

The HHC is capable of comparing two measurements in several configurations

- Pressure or temperature input to current output device, such as a transducer with 4-20 mA output
- Pressure or temperature input to voltage output device, such as a transducer with 0-10 Vdc output
- Pressure to pressure device, such as a pneumatic controller
- Current input to pressure output device such as a pressure regulator with 4-20 mA input signal

All input and output parameters can be programmed by the operator.

Datalogging is possible while using the HHC in Percent Error Mode. Datalogs will include only the actual values measured. Datalogs will not include the percent error calculation as displayed on the HHC screen.

For example, if the HHC is being used to calibrate a 0-100 psi transmitter with 4-20 mA output the HHC will display the following data:

- Input pressure, as measured by Quick-Select pressure module in selected engineering units that is being applied to the device under test. This is the standard against which the device under test is being compared.
- Output, from the transducer under test in output units (milliamps)
- Percent error, calculated by comparing the theoretical milliamp output of the device under test based on the measured pressure reading, against the actual measured output of the device under test. The HHC will indicate whether this error is positive or negative as compared to the theoretical output.

If 50.00 psi is applied to a 0-100 psi pressure transducer with a 1-5 Vdc output, the theoretical output will be 3.000v. If the measured output from the transducer is 3.015v, the HHC will display the following:

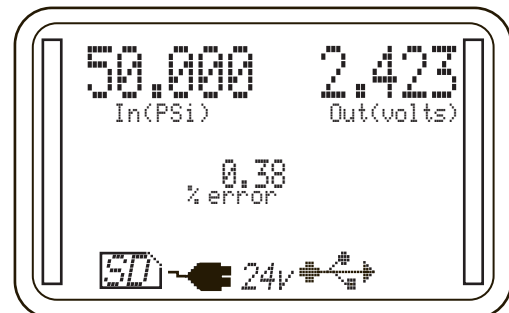
**% Error terms**

Input refers to any pressure or electrical signal input to both the device under test and the pressure or temperature module in the HHC.

Input Channel refers either to a pressure or temperature module installed in the base unit (CH1 or CH2), or a voltage or current signal connected to the common and input jacks.

Input Range refers to the numeric full scale range of the input parameter. It is not necessary to program an engineering unit for the input range. For example, a pressure transducer with a measurement range of 0 to 100 psi. The engineering unit is automatically determined by the channel selected (pressure, temperature, voltage or current).

**PERCENT (%) ERROR FUNCTION
CONT.**



Output refers to any output signal from the device under test.
Output channel refers to the channel on which the device under test is sending its output signal. For example a pressure transducer with 0-10 VDC output would be connected to the HHC's External input, referring to the banana jacks labeled COM and 0-33 Vdc In.

Output range refers to the numeric range of the output of the device under test. In the example above the range would be 0 to 10. Engineering units are determined by the channel on which the output signal is transmitted.

There is no need to program parameters referring to modules installed in the HHC as they are recognized by the base unit.

To set up the Percent Error Function the HHC must be properly connected to the device under test and have appropriate Quick-Select modules installed.

If testing pressure transducers, a pressure source such as a hand pump, regulated clean shop air or dry nitrogen is required to apply pressure to the device under test and the HHC pressure module.

Note: See section 14j for wiring diagrams.

If using the internal power supply be sure that it has been turned on in the main MENU and "24v" is indicated on the display.

Note: If the device under test is a voltage or current output device, the "mA/V" key must be used to activate current or voltage monitoring prior to programming the test parameters.

For the following procedure description assume that the device under test is a pressure transducer measuring 10-110 psi with a voltage output of 1-6 Vdc.

Programming set up for Percent Error function

- Press MENU key
- Use DOWN or UP ARROW to highlight Modes...
- Press ENTER
- Use DOWN or UP ARROW to highlight Percent error...
- Press ENTER
- Use DOWN or UP ARROW to highlight Input Channel...
- Press ENTER

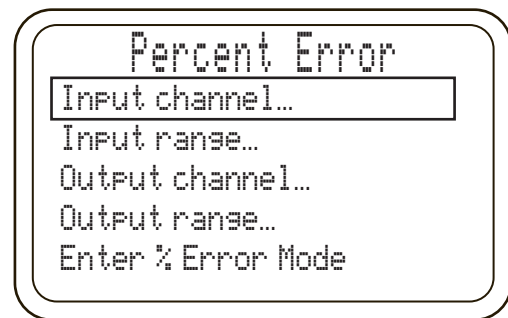

Use DOWN or UP ARROW to highlight "CH1" (Channel 1 Module) or "CH2" (CHANNEL 2 module) or "External Input..."
Press ENTER

HHC will go back to Percent Error MENU and advance to the next programmable parameter...

Use DOWN or up ARROW to highlight "Input range..."

Press ENTER

HHC will display Input Range selection screen

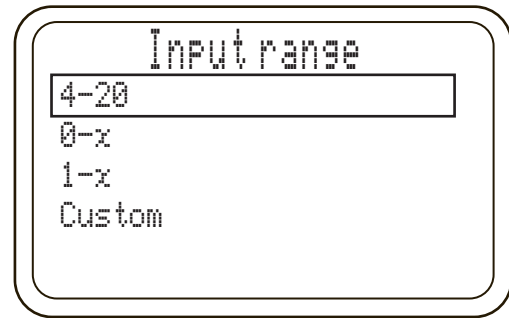
**PERCENT (%) ERROR FUNCTION
CONT.**

Use DOWN or UP ARROW to highlight 4-20, 0-X, 1-X or Custom
 Note: If a range ending in "-X" or "Custom" is selected the operator can program the numeric value for the variable as follows

If a custom range is required:

Use DOWN or UP ARROW to highlight "Custom"...

Note: programming of Custom and "X" values uses similar procedures for setting numeric values and decimal positions.

Input Zero screen will be displayed.

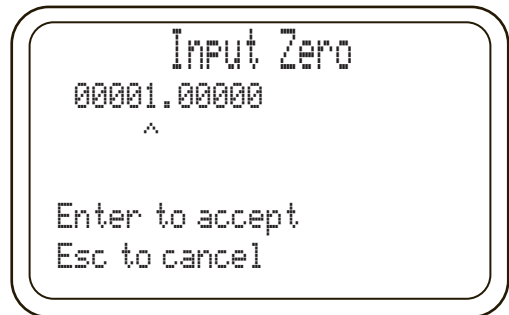

Press left and RIGHT ARROWS to position cursor (^) beneath desired numeric character.

Press UP and DOWN ARROWS to scroll numeric values.

When desired numeric value is displayed in proper decimal position

Press left or RIGHT ARROW to move cursor beneath the next digit to be programmed.

When desired Zero input value is displayed on screen for example 00010.00000

Press ENTER to accept

Input FS (Full Scale) screen will be displayed.

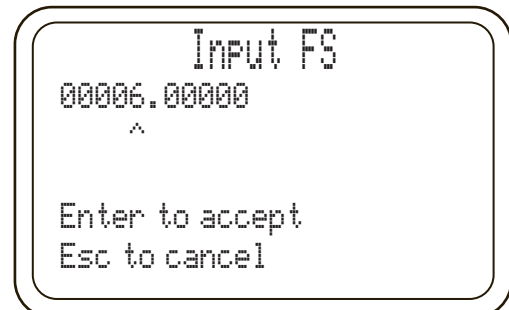

Press left and RIGHT ARROWS to position cursor beneath desired numeric character.

Press UP and DOWN ARROWS to scroll numeric values.

When desired numeric value is displayed in proper decimal position

Press left or RIGHT ARROW to move cursor beneath the next digit to be programmed.

**PERCENT (%) ERROR FUNCTION
CONT.**

When desired FS input value is displayed on screen for example 00110.00000

Press ENTER to accept

HHC will go back to Percent Error MENU and advance to the next programmable parameter.

Use DOWN or UP ARROW to highlight "Output channel..."

Press ENTER

Use DOWN or UP ARROW to highlight "CH1" (Channel 1 Module) or "CH2" (Channel 2 module) or "External Input..."

Note: Typically external input is used with transducers that provide voltage or current output signals.

Press ENTER

HHC will go back to Percent Error MENU and advance to the next programmable parameter..

Use DOWN or UP ARROW to highlight "Output range..."

Note: Typically this is the output range of the device under test. For this example the unit under test has 0-6Vdc output.

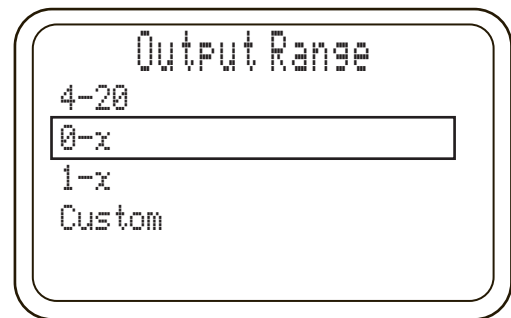

Use DOWN or UP ARROW to highlight "4-20", "0-X", "1-X" or "Custom"

If a range ending in "-X" or "Custom" is selected the operator can program the numeric value for the variable as follows

Use DOWN or UP ARROW to highlight "0-X"

Output "0-X" screen will be displayed.

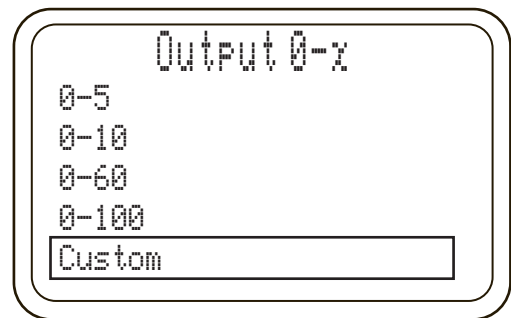

Use DOWN or UP ARROW to highlight "0-5" through "0-100", if desired value is not displayed select "Custom"

If a custom range is needed:

Select "Custom"

Press ENTER

Display shows "Input FS screen"

SECTION 15 h.

**PERCENT (%) ERROR FUNCTION
CONT.**

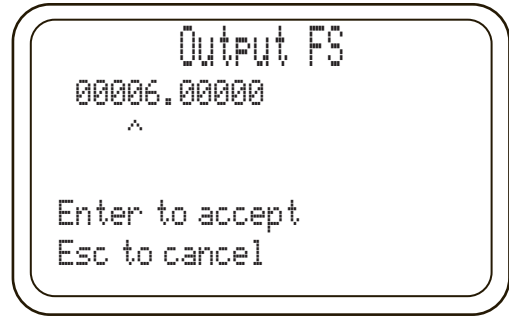

Press left and RIGHT ARROWS to position cursor beneath desired numeric character
Press UP and DOWN ARROWS to scroll numeric values.
When desired numeric value is displayed in proper decimal position
Press left or RIGHT ARROW to move cursor beneath the next digit to be programmed
When desired Full scale value is displayed on screen for example 00006.00000
Press ENTER to accept
HHC will go back to Percent Error MENU and advance to the next programmable parameter.
Use DOWN or UP ARROW to highlight “Enter % Error Mode”
Press ENTER
The HHC is now actively measuring the Percent Error of the device under test.

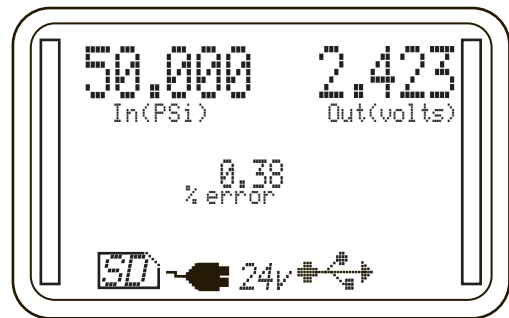

SECTION 15 i.

DUAL MODE FUNCTION

The HHC is equipped with firmware that can add or subtract the measured pressure values from two installed Quick-Select pressure modules. This allows for measurement of what are commonly referred to as “high-line” or elevated static differential pressures. The ability to add the measured values of the two installed Quick-Select pressure modules allows for the addition of a measured barometric pressure from an absolute pressure module to the measured pressure from a gauge or differential pressure. This capability can use gauge measurement Quick-Select pressure modules for absolute pressure measurement.

Accuracy of Dual Module Measurements

The accuracy of measurements made using the difference or sum of two modules is a function of the full scale range of the Quick-Select pressure modules used and, in the case of differential pressure measurements, the magnitude of the differential pressure range.

For dual sensor summation measurements:

The worst case inaccuracy would be the sum of the inaccuracies of the two Quick-Select modules used for the measurement. For example, if the measurement is made with two +0.1% full scale modules the maximum inaccuracy would be +0.2%. In actual use, it is generally acceptable to use the Root Sum of the Square (RSS) method of determining the accuracy of a multiple component measurement system. Using the RSS method the accuracy of the dual module summation is approximately +0.14% of span.

Dual sensor differential measurements will have similar accuracy specifications.

To access Dual Module Functions:

Press MENU key

Use DOWN or UP ARROW to highlight "Modes..."

Press ENTER

Use DOWN or UP ARROW to highlight "Dual module functions..."

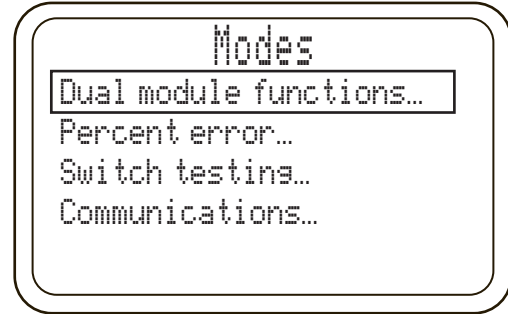

Press ENTER

Press DOWN or UP ARROW to highlight "Differential CH1-CH2", "Differential CH2-CH1", or "Additive (CH1+CH2)"

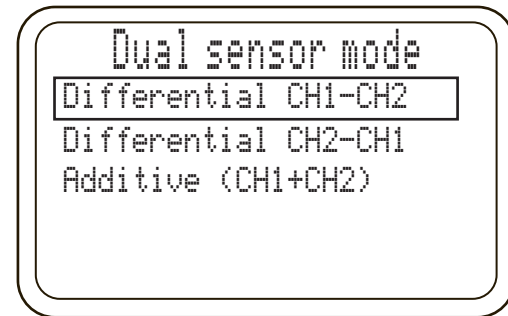

Press ENTER

Display will show a single value indicating desired pressure calculation.

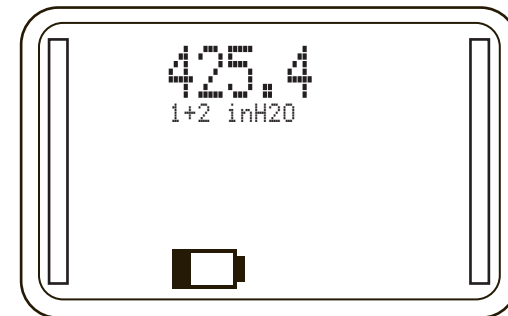

The HHC can be used with most standard RTD (Resistive Temperature Detector) probes to provide precision temperature measurements. An XXX -RT1 or XXX -RT2 Quick-Select module is needed to interface an RTD probe to the HHC. There are two XXX -RT Quick-Select module types available to support RTD resistance levels and capabilities indicated in the table below:

RTD TEMPERATURE MEASUREMENT CONT.

	XXX-RT1	XXX-RT2
Ohms Measurement Range	0 - 400 ohms	0 - 4000 ohms
Factory Programmed RTD Probe 01	Pt100 385: -200 to 500C ±0.15C	Pt1000: 184 to 275C ±0.15C
Factory Programmed RTD Probe 02	Pt100 392: 550 to 850C ±0.2C	----
Factory Programmed RTD Probe 03	Ni 120: 80 to 260C ± 0.1C	----
Factory Programmed RTD Probe 04	Cu 10: 70 to 150C ± 0.6C	----
Available User Programmable TD Probes	4	7
Ohms	+0.01% reading +0.02ohms	+0.01% reading +0.2ohms

Both modules can display temperature units of Fahrenheit, Celsius, Kelvin, Rankine, and also support reading output in units of ohms.

The electrical interface of the probe to the module incorporates a Switchcraft TA4M type connector and requires an RTD with the appropriate mating connector. The connector is available through the supplier of your choice.

Setting up the PTE-2 for an RTD Temperature Measurement

Insert the appropriate XXX-RT Quick-Select RTD Interface Module.

Connect the desired RTD probe to the Switchcraft connector on the XXX-RT module.

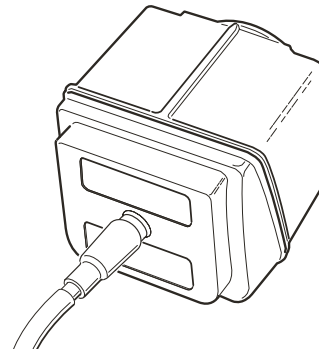

Note: RTD probes can be connected using two, three or four wire configurations. Use of four wire configuration is recommended for optimum accuracy. RTD probes provided by this manufacturer are of the four wire configuration.

To select RTD probe characteristics

Install an RTD Quick-Select Module and Probe in the HHC Base Unit.

Press MENU key

Use DOWN or UP ARROW to highlight "Setup..."

Press ENTER

Use DOWN or UP ARROW to highlight "Module..."

Press ENTER

Use DOWN or UP ARROW to highlight "RTD..."

Press ENTER

RTD Module programming screen will appear

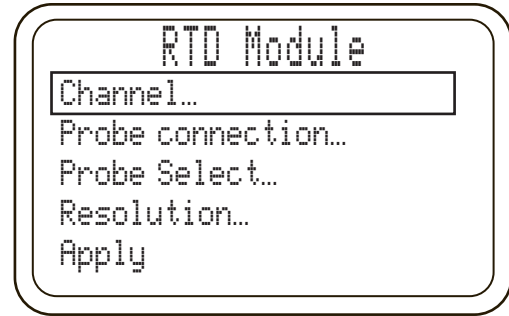
**RTD TEMPERATURE
MEASUREMENT CONT.**

Use DOWN or UP ARROW to highlight "Channel"..
 Press ENTER
 Use DOWN or UP ARROW to highlight "CH1" "CH2"
 Press ENTER

Note: If the incorrect type of module is installed a "MODULE ERROR" message will be shown.

Return to RTD Module screen
 Use DOWN or UP ARROW to highlight "Probe connection.."
 Press ENTER
 Use DOWN or UP ARROW to highlight "2-wire...", "3-wire...", or "4-wire..."
 Press ENTER
 Return to RTD Module screen
 Use DOWN or UP ARROW to highlight "Probe select..."
 Press ENTER
 Use DOWN or UP ARROW to highlight "Probe 01 through 08..."
 (per table above)
 Press ENTER
 Return to RTD Module screen
 Use DOWN or UP ARROW to highlight "Resolution..."
 Press ENTER
 Use DOWN or UP ARROW to highlight "1", "0.1", "0.01" or "0.001"
 Press ENTER
 Return to RTD Module screen
 Use DOWN or UP ARROW to highlight "Apply"
 Press ENTER

Programmed settings are saved to memory and HHC returns to Measurement Mode with RTD operating as programmed above.

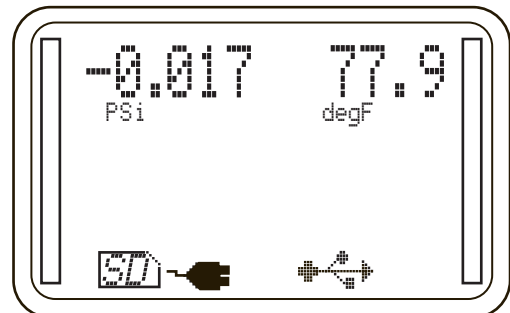

Note: The maximum resolution that the combination of the HHC base unit and the RTD interface module and probe can support can be determined as follows:

The resolution of the RTD module is 0.001% of the full scale resistance of the reference resistor used in the module. The XXX-RT1 incorporates a 400 ohm reference resistor and the XXX-RT2 incorporates a 4000 ohm resistor.

Using the XXX-RT1 with a PT100 probe as the example the maximum resolution is:

$$0.001\% \text{ of } 400\text{ohms} = 0.004 \text{ ohms}$$

$$0.004 \text{ ohms} / (100 \text{ ohms} \times 0.00385 \text{ ohms/degree}) = 0.0104 \text{ degrees C}$$

Therefore rounding to the nearest digit results in a resolution of

SECTION 15 j.

RTD TEMPERATURE MEASUREMENT CONT.

0.01 degrees C.
Supported Resolutions for Factory Programmed Probes:

XXX-RT1 Pt100	0.01 degrees C (385 & 392)
XXX-RT1 Ni 120	0.1 degrees C
XXX-RT1 Cu 10	0.1 degrees C
XXX-RT2 Pt1000	1.0 degrees C

SECTION 15 k.

THERMOCOUPLE TEMPERATURE MEASUREMENT

The HHC can be used with several standard Thermocouple types for precision temperature measurements. The Thermocouple Interface Module XXX-TC1 allows the HHC base unit to read the input of a thermocouple measuring device. The XXX-TC-1 thermocouple modules support the following thermocouple types:

TYPE	Material
J	Iron & Copper (Constantan)
K	Nickel-Chromium & Nickel-Aluminum
T	Copper & Copper-Nickel (Constantan)
E	Nickel-Chromium & Copper-Nickel (Constantan)
R	Platinum-13% Rhodium & Platinum
S	Platinum-10% Rhodium & Platinum
B	Platinum-30% Rhodium & Platinum-6% Rhodium
N	Nickel-Chromium-Silicon & Nickel-Silicon-Magnesium

Several parameters associated with Thermocouple temperature measurement can be selected including:

- Engineering units or direct millivolt readout for any type of thermocouple
 - Choice of internal or external reference junction
 - Selectable resolution or automatic resolution (selects maximum possible)
1. Attach the thermocouple to a male miniature thermocouple connector (Omega type SMPW) to the module. Install the thermocouple into the interface module by inserting the metal blades of the miniature connector into the slots in the receptacle located on the thermocouple interface module.

Note: Connectors are specifically manufactured for each thermocouple type and will be marked accordingly. Failure to use the properly mated connector will result in additional inaccuracy.

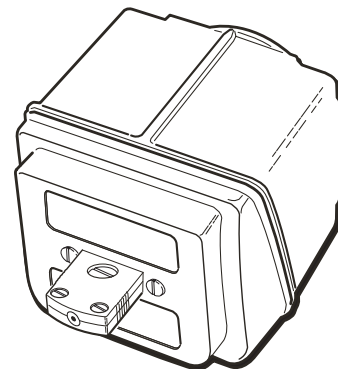

2. Install the thermocouple interface module into either of the two HHC module bays.

To Setup Thermocouple Module and Probe Type.

Press MENU key
 Use DOWN or UP ARROW to highlight "Setup..."
 Press ENTER
 Use DOWN or UP ARROW to highlight "Module..."
 Press ENTER
 Use DOWN or UP ARROW to highlight "Thermocouple"
 Press ENTER
 "TC Module" programming screen will appear

**THERMOCOUPLE TEMPERATURE
MEASUREMENT CONT.**

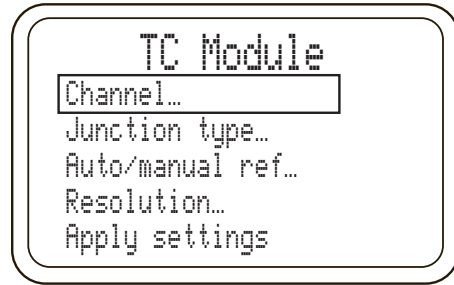

Use DOWN or UP ARROW to highlight "Channel..."
Press ENTER
Use DOWN or UP ARROW to highlight "CH1" "CH2"
Press ENTER

Note: If the incorrect type of module is installed a "MODULE ERROR" message will be shown.

Return to TC Module screen
Use DOWN or UP ARROW to highlight "Junction type"...
Press ENTER
TC Junction type screen appears.
Use DOWN or UP ARROW to scroll through Thermocouple types J,K, T, E, R, S, B,N "
When the desired TC type is displayed
Press ENTER

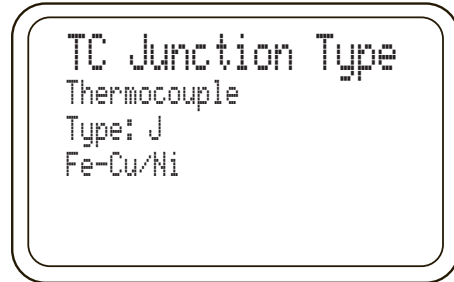

Note: By selecting the thermocouple type the PTE-2 will access the factory programmed coefficients in the module which will allow the PTE-2 to display in a unit of temperature
Return to TC Module screen
Use DOWN or UP ARROW to highlight "Auto/manual ref..."
Press ENTER
Use DOWN or UP ARROW to highlight "Auto or Manual..."
By selecting the "Auto" mode, the calibrator will utilize the internal thermistor/resistor based on the reference junction that is resident inside the interface module.
The "Manual" mode allows for the use of an external reference junction. A stable temperature reference, usually in the form of an ice bath, is required.
Press ENTER
If the "auto" mode was selected, the calibrator will now return to TC Module screen with "Resolution" highlighted, skip to Resolution programming.
If Manual was selected continue below

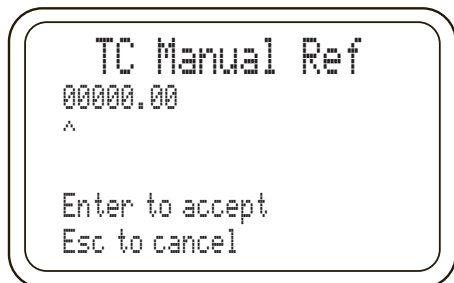

SECTION 15 k.

THERMOCOUPLE TEMPERATURE MEASUREMENT CONT.

Press left and RIGHT ARROWS to position cursor beneath desired numeric character.
 Press UP and DOWN ARROWS to scroll numeric values.
 When desired numeric value is displayed in proper decimal position, press LEFT or RIGHT ARROW to move cursor beneath the next digit to be programmed.
 Continue until all required digits are populated on the display.
 When desired Reference temperature value in selected engineering units is displayed on screen for example
 0070.00
 Press ENTER to accept
 HHC will go back to TC Module MENU and advance to the next programmable parameter "Resolution"....
 With "resolution..." highlighted press ENTER
 Use DOWN or UP ARROW to highlight "1, .1, .01 or Auto"
 Note: If selecting "Auto", the calibrator will adjust the display to the greatest significant resolution.
 Press ENTER
 TC Module programming screen will appear with "Apply" highlighted.
 If previously programmed settings are acceptable press ENTER
 HHC will enter Measurement Mode and display temperature as programmed.

SECTION 15 l.

FIRMWAREUPDATE

The HHC is shipped with the latest firmware (application software) available at the time of manufacture. When firmware updates are released, they will be made available on our website. The following steps outline the process of updating the HHC's firmware:

- 1) Install the FDTI USB Driver on the Host PC.
- 2) Install the HHC Firmware updater on the Host PC.
- 3) Download the HHC Firmware Image to the Host PC.
- 4) Connect the HHC to the Host PC.
- 5) Run the HHC Firmware Updater on the Host PC.
- 6) Transfer the firmware file

1) Install the FTDI USB Driver on the Host PC:

Before connecting the HHC to your desktop computer, you must install the correct USB driver. Installing this driver will allow Microsoft Windows to recognize the HHC as a standard COM port. Windows will assign the next available COM Port Number to the HHC. For example: COM4.

Note: This driver may already be installed on your PC.

This driver is available from a third party, Future Technology Devices International, and is also included on the memory stick that you received with your HHC.

The internet link to the driver is:

<http://www.ftdichip.com/Drivers/CDM/CDM 2.08.30 WHQL Certified.zip>

On the supplied memory stick:

D:\HHC_Uilities\FTDI_Driver\CDM 2.08.30 WHL Certified.zip

2) Install the HCC Firmware Updater on the Host PC:

The "HHC Firmware Updater" is a Windows software utility that allows you to transfer an HHC firmware image, in the form of a ".cyacd" file, from your PC to the HHC via the USB Port.

D:\HHC_Uilities\HHCfirmwareupdater\setup.exe

Note: The installer may prompt you to install their ".NET" software which is required by HHC Firmware Updater.



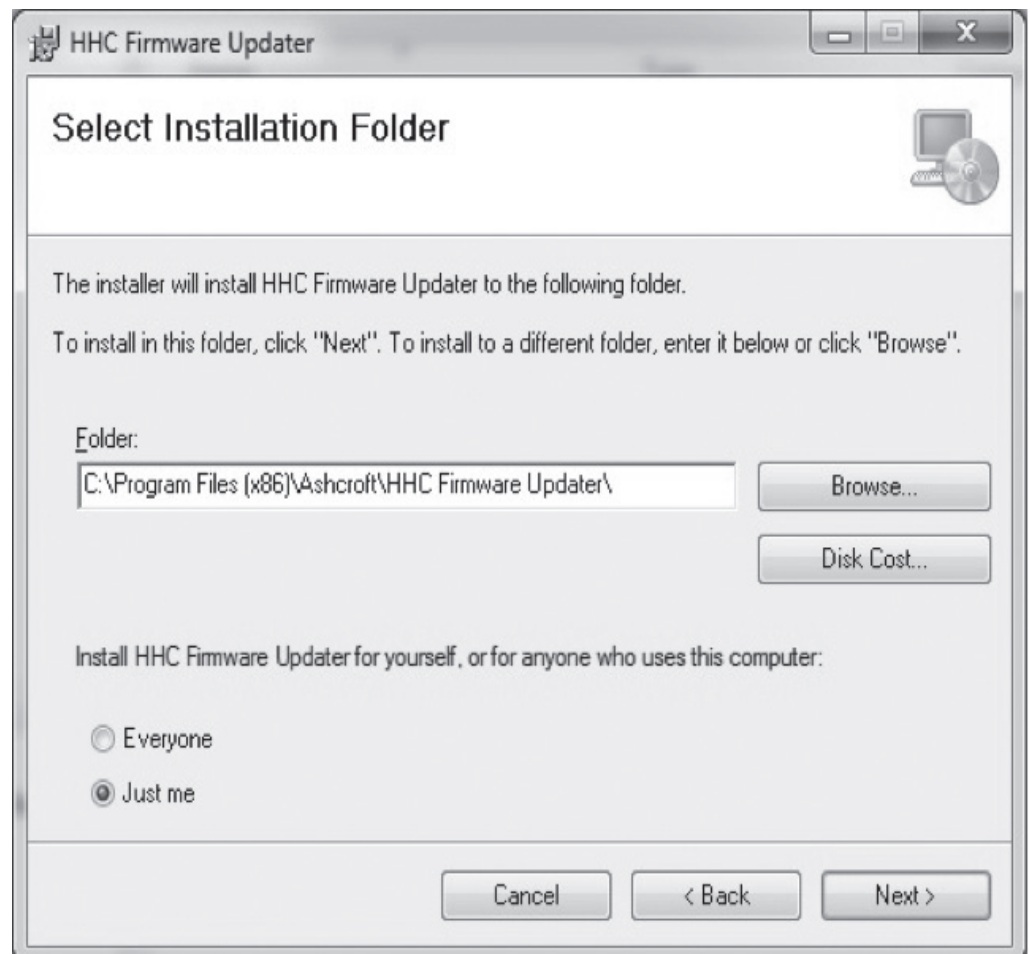

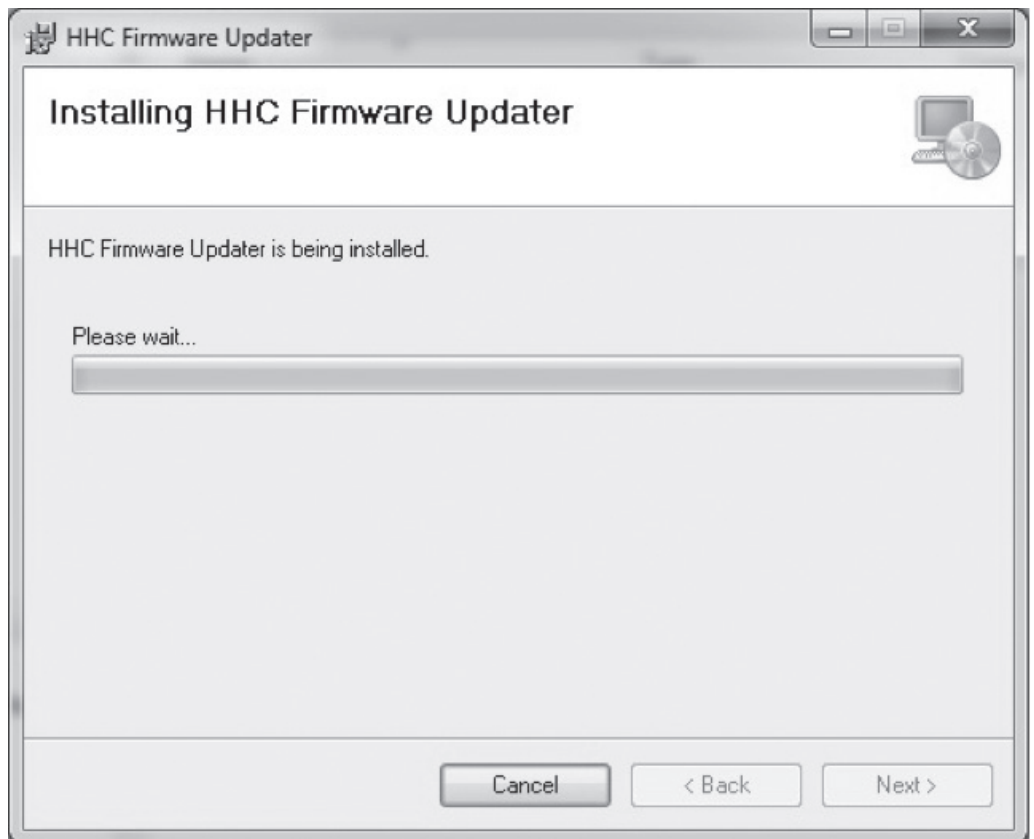
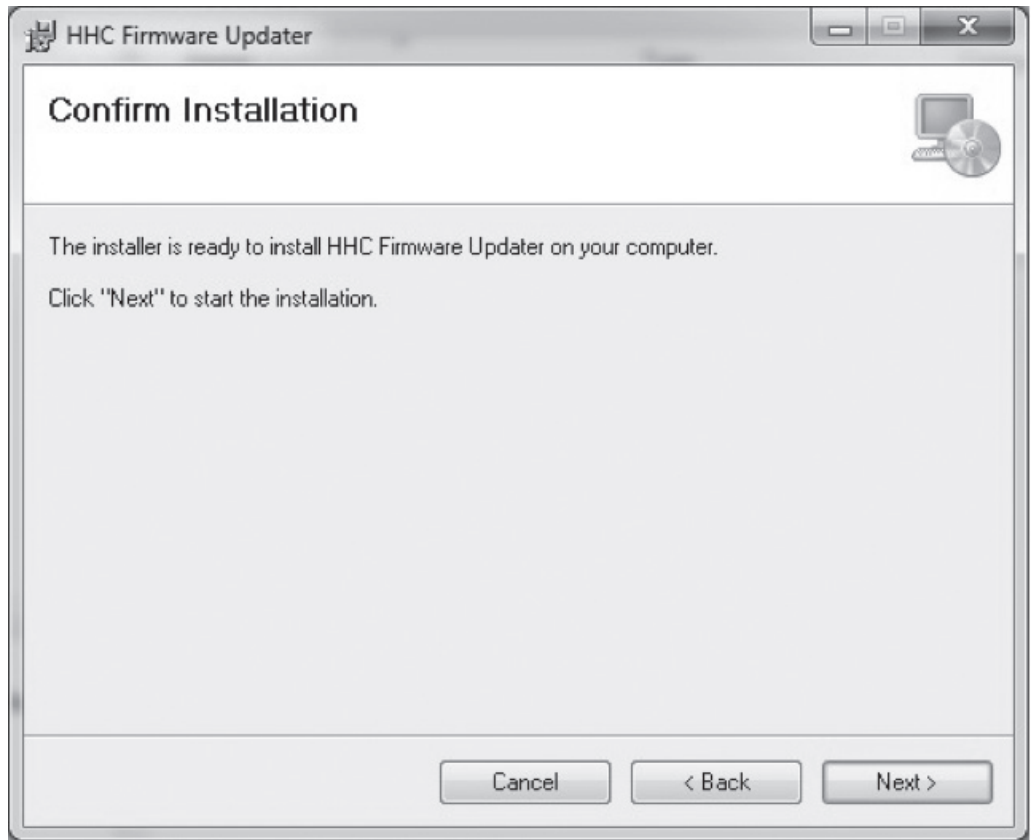

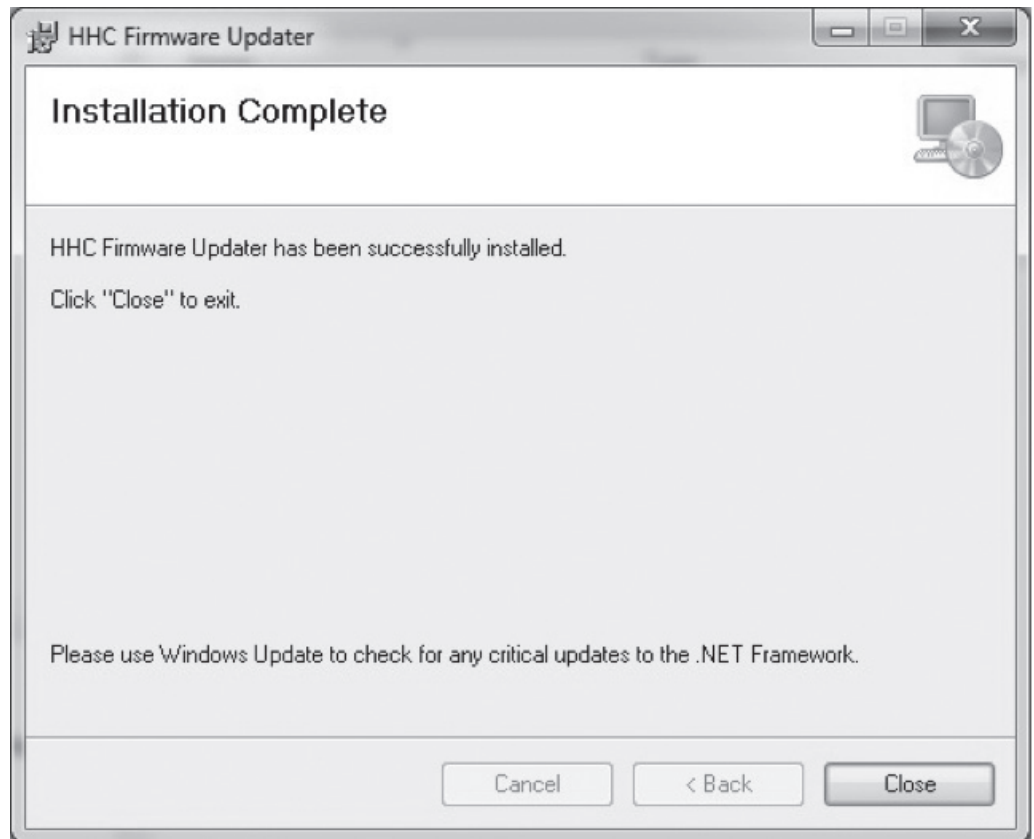

3) Download the HHC Firmware Image to the Host PC:

HHC Firmware images have the filename extension “.cyacd”.
Example: “pte2 v_050-083.cyacd”

Simply copy this file onto your local hard drive, making a note of its path so you can find it.

4) Connect the HHC to the Host PC:

Using the supplied USB cable, connect the HHC to an open USB port on your Host PC.

Initiate Firmware Updater on HHC Base Unit

Power up the HHC and place it in “Firmware Updater” mode using the following steps:

Press MENU key

Press DOWN or UP ARROW key to highlight “Setup...”

Press ENTER

Press DOWN or UP ARROW key to highlight “System...”

Press ENTER

Press DOWN or UP ARROW key to highlight “Firmware Update”

Press ENTER

Once in the Updater Mode, the HHC will display the power up “Splash Screen” and freeze. The HHC is now ready to accept the firmware download.

Note: If the application firmware is missing or corrupt, the unit will remain in the “Firmware update” mode on power up. This will allow you to run the “HHC Firmware Updater” and repair the application.

5) Run the HHC Firmware Updater on the Host PC:

Double-click on the desktop icon for the “HHC Firmware Updater”



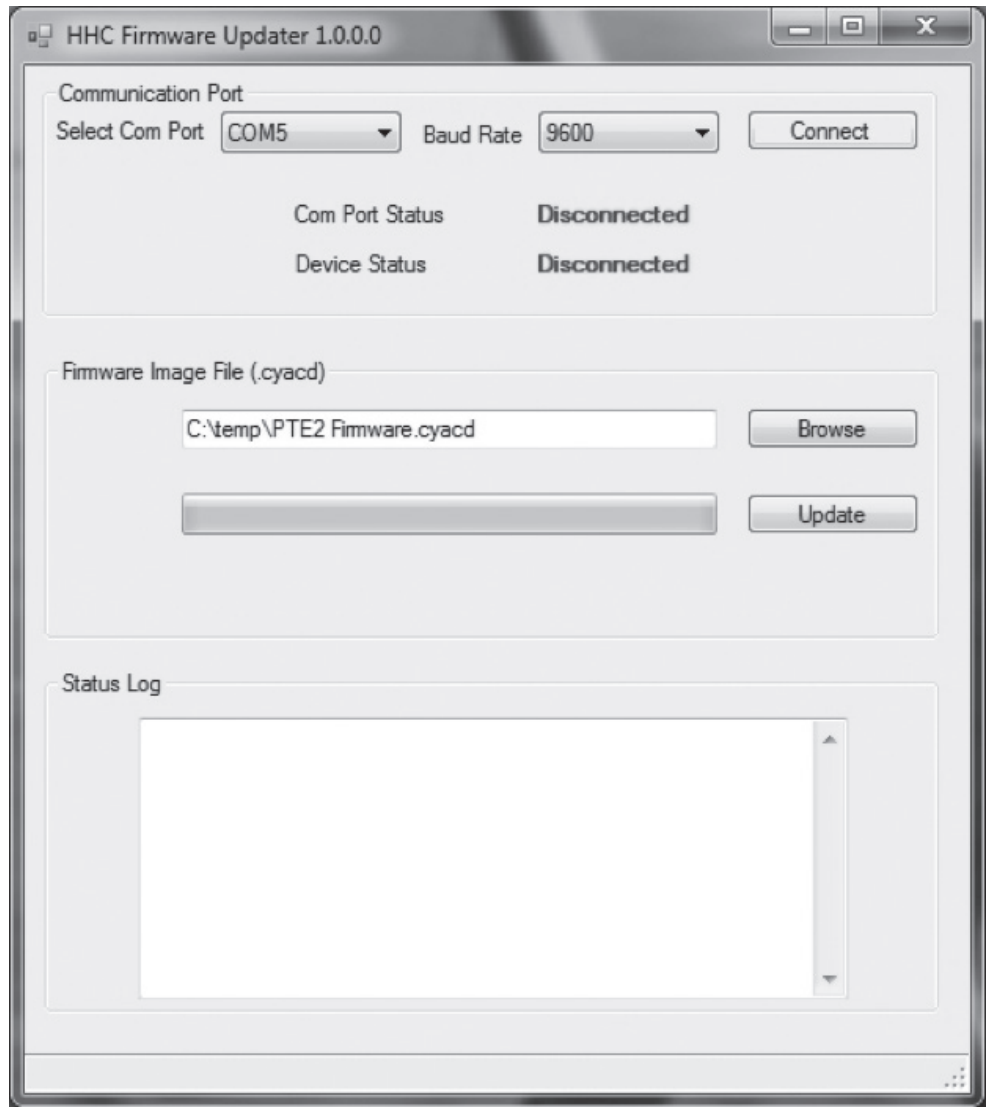

Select the appropriate COM port.

TIP: When you pull DOWN “Select Com Port” it scans your computer and presents a list of available COM Ports. If you do this before and after connecting the USB cable to the HCC, you should see an extra com port with the HHC connected. Select that new port. If the HHC does not appear as a COM Port, make sure that you have installed the FTDI USB Driver.

Click [Connect].

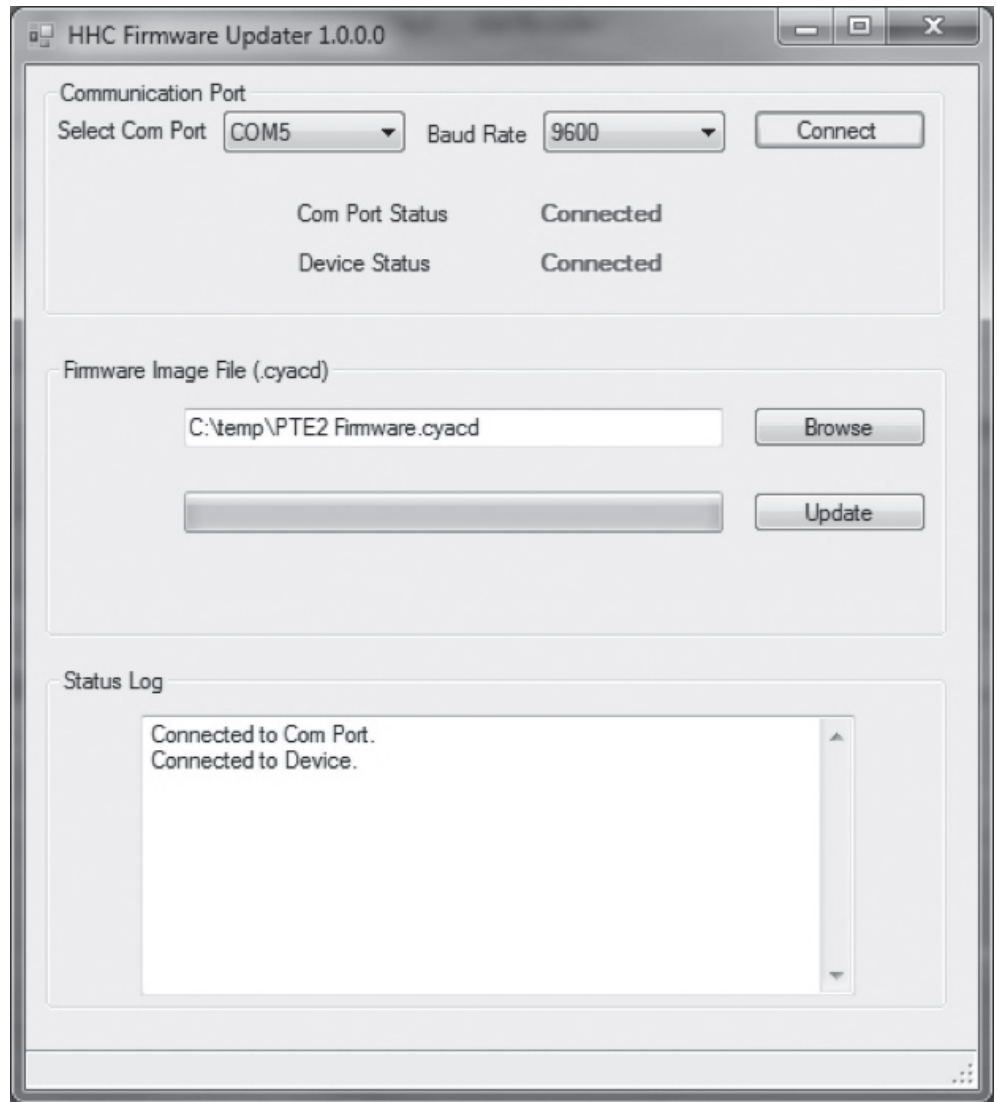

Both the “Com port status” and the “Device Status” should indicate “Connected”.

NOTE: If the “Com Port Status” is “Connected” and the “Device Status” is “Disconnected” you most likely have the wrong COM port or the device is not in the “Firmware Update” mode. If unsure of the correct COM port number disconnect the USB cable from the PC then reconnect to have the PC display a message stating the new COM port number.

Select the desired Firmware Image File with the suffix “.cyacd” by clicking the [Browse] button and locating the file.

Click [Update] to begin transfer

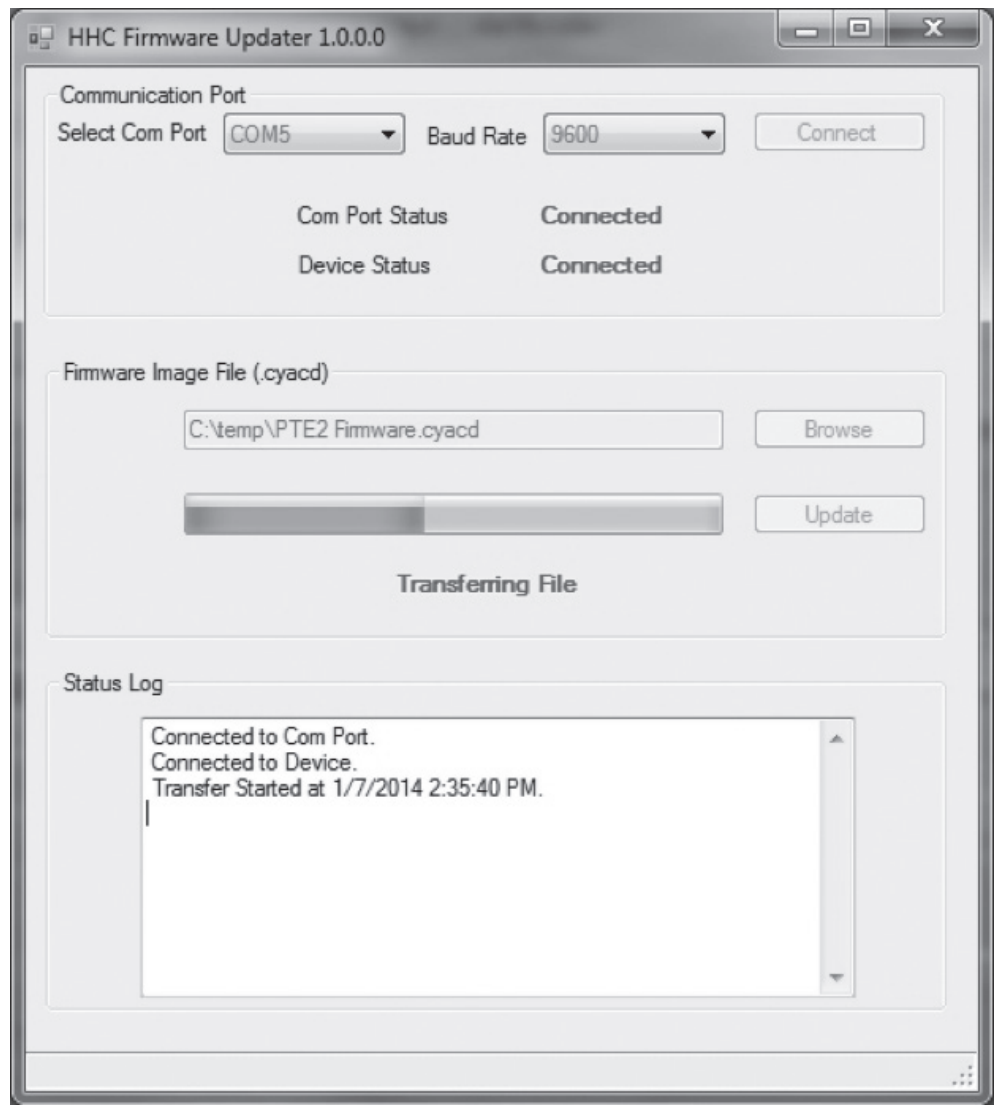

Note: The File Transfer can take up to 15 Minutes.

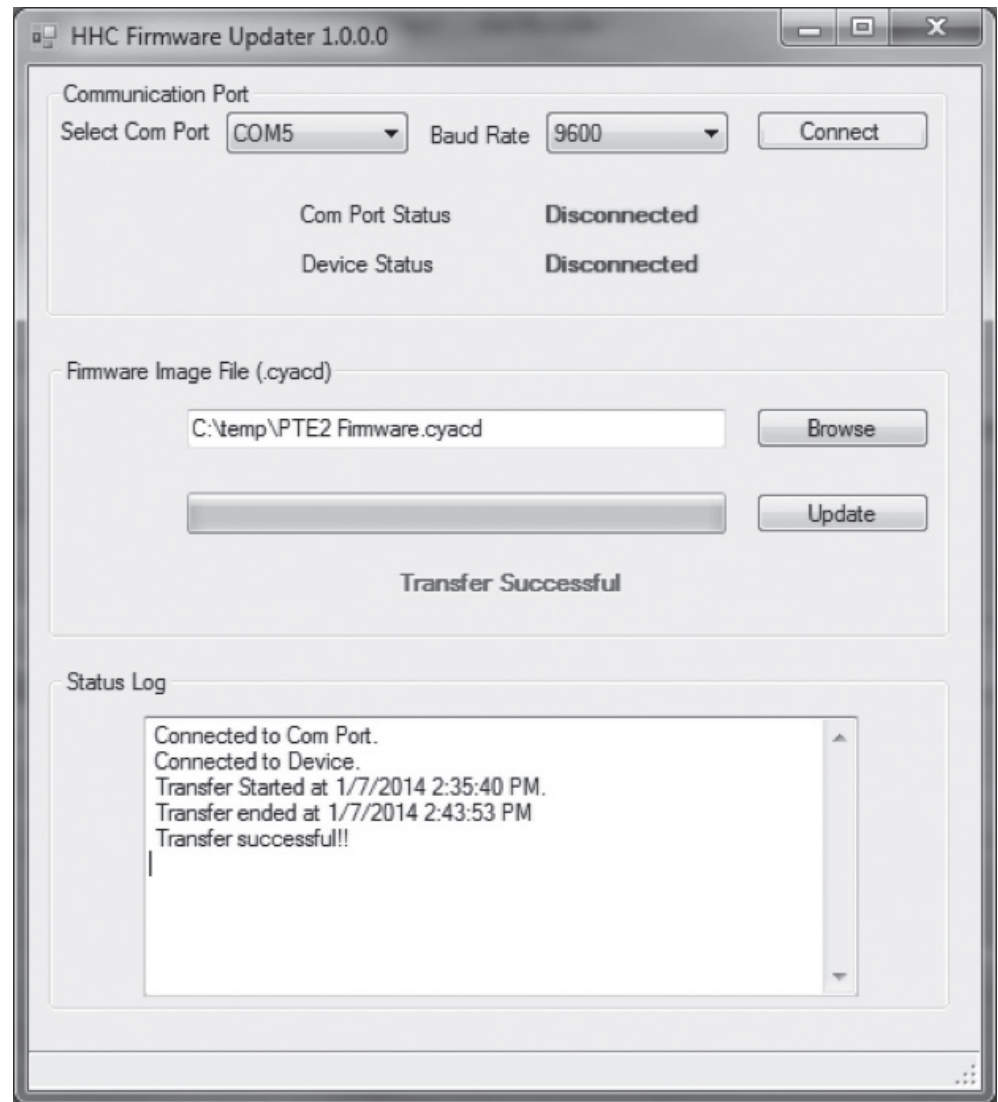

When the "Transfer Successful" message is displayed the process has completed. You can verify the update was successful by powering on the HHC base unit and noting the new firmware revision number displayed during boot up and in the "about this HHC..." MENU under Setup/System.

The HHC can be connected to a PC running Windows XP or Windows 7 or 8 via the USB port. Windows will recognize the HHC as a Communications Port. The HHC has three communication protocol modes:

Inquiry/Journal mode: These communications modes are included in standard HHC models. HHC acquisition data can be accessed via a Windows terminal emulation programs including Windows HyperTerminal or TeraTerm.

Inquiry mode is similar to manual datalogging where a data point will be sent to the PC based on a user defined character from the PC keyboard.

Journal mode is similar to Automatic Datalogging mode where the operator can set a timed interval between data points being communicated to the PC.

In the Journal/Inquiry communications mode the HHC will output a string indicating the current acquired data from modules and external inputs. The string will contain the data and units for the Channel 1, Channel 2 modules as well as the external input (mA/V). Each item is delimited by a space character. The items will be the same as are enabled on the HHC display.

<CH1 Module Value> <CH1 Units> <CH2 Module Value> <CH2t Units> <External Value> <External Units>

for example:

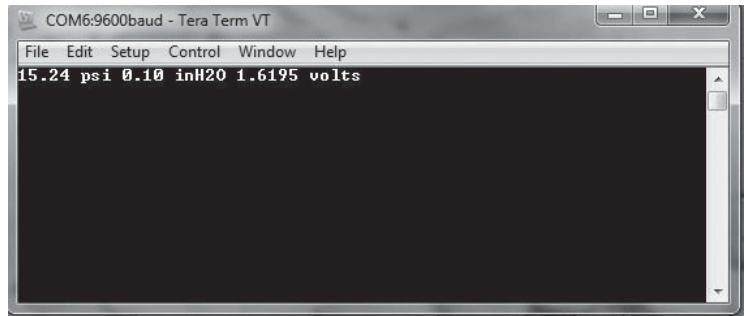

Other communication protocols:

ISO1745: Using the standard ISO1745 communication protocol format the HHC exposes commands for acquiring data, accessing internal calibration data, and accessing datalogs. ISO1745 commands and format are documented in Appendix C in section 16c of this manual.

MODBUS: This mode is optional. Using the standard MODBUS RTU communication protocol format, the HHC exposes commands for acquiring data and accessing internal calibration. MODBUS commands and format are documented in Section 16c.

Windows programming environments that support com ports, (Visual Basic, Visual C#, LabView, etc.), may use one of the above modes to acquire data from the HHC.

USB Cable Installation

To expose the com port, the access cover must be removed with a Phillips head screwdriver.

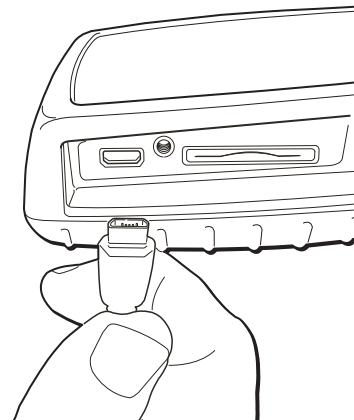

SECTION 15 m. i.

USB Cable Installation Cont.



IMPORTANT NOTE for INTRINSICALLY SAFE APPROVED VERSIONS OF THE Hand Held Calibrator

1. When access port is open, the device is not operating in an Intrinsically Safe mode. As such it is not possible to use the HHC in a hazardous area whenever the USB port is exposed or if the port access door is not secured with Philip's head screw.
2. When using an Intrinsically Safe approved HHC in a non-hazardous environment, the USB protection adaptor must be used to connect the HHC to a PC's USB port. Failure to install the USB protection adaptor can result in damage to the electronics which could render the HHC no longer intrinsically safe.

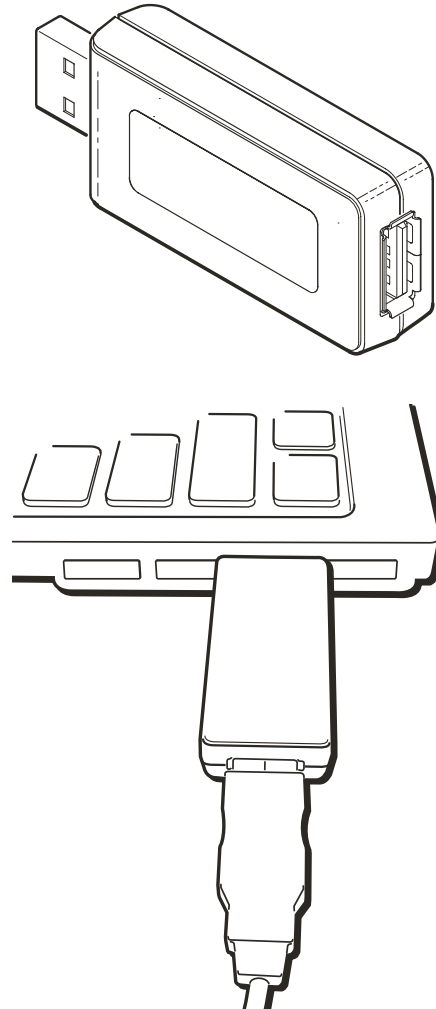

SECTION 15 m. ii.

Driver Installation

Driver Installation

If the PC being used together with the HHC does not already have the proper drivers installed it will be necessary to install a driver to enable communication.

The HHC need not be powered on for the driver installation.

Place the memory stick that came with the HHC in one of the PC's USB ports.

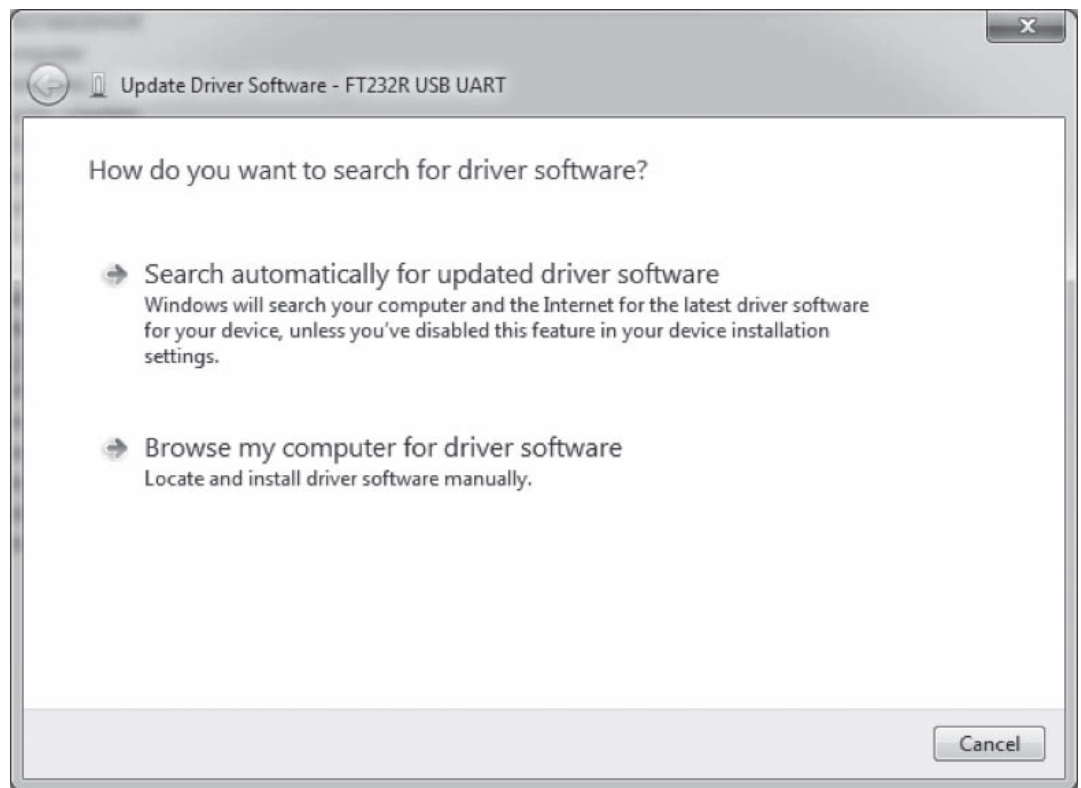

The dialog below will appear. Click “Browse and navigate to the drive with the memory stick, then click Next.



Windows will install the driver. Once complete an HHC will enumerate as a Communications Port on this computer. The driver installation should not have to be performed again.

SECTION 15 m. ii.

Driver Installation Cont.

The HHC will appear as a Communications Port on a Windows PC. It will be assigned the port number of the first available port on the PC. To determine which port number has been assigned look in the Windows Device Manager. This can be accessed by the Windows Control Panel under System or by right clicking on your My Computer Icon, selecting Properties and Device Manager.

In Device Manager expand Ports to see which USB Serial Port is assigned to the HHC. In the example below the HHC is shown as COM 8. You may connect more than one HHC to a PC; each will have its own COM Port assignment.

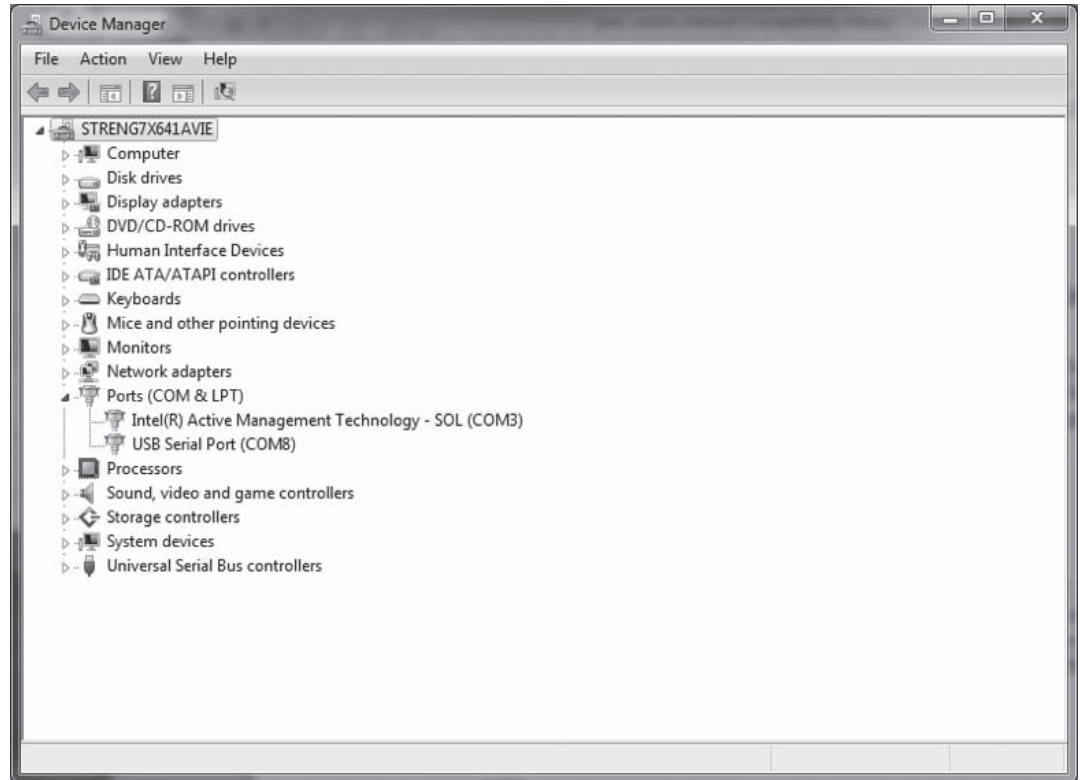

SECTION 15 m. iii.

Terminal Setup

Terminal or Programming environment setting

The Com Port Selection in the software must be set to the com port number shown in Device Manager. This Com Port appears only while the HHC is connected.

Configuration Settings to use:

- 9600
- 8 Data Bits
- 1 stop
- No Parity
- No handshaking

Note for Terminals: The HHC does not echo characters received, the user may want to enable local echo.

Modes of Communication:

The HHC can automatically determine which of its three modes is to be used (Inquiry/Journal, ISO1745 or MODBUS). After Power-on the HHC uses the first received command from the PC to establish which mode it will operate in. It will recognize the format of the first command and remain in that mode until switched by the user via the Setup Communications Mode MENU or the next power off/on.

Set up of the HHC Communication modes are available through the programming MENU.

Inquiry Mode**Set up Inquiry Mode**

Inquiry mode is similar to manual datalogging where a data point will be sent to the PC based on a user defined character or the Enter key being pressed from the PC keyboard.

Press MENU key

Use DOWN or UP ARROW to highlight "Modes..."

Press ENTER

Use DOWN or UP ARROW to highlight "Communications ..."

Press ENTER

Use DOWN or UP ARROW to highlight "Journal/Inquiry....."

Press ENTER

Use DOWN or UP ARROW to highlight "Inquiry character..."

Press ENTER

Display will show "Set Inquiry Char"

Use DOWN or UP ARROW to select a Character

Press ENTER

Notes:

- This is the character on the PC keyboard that will trigger data being collected from the HHC each time the character is pressed.
- The default character from the factory is the carriage return (Enter Key on a PC keypad)
- Upper case and lower case characters are available for selection. However, data transmission will be initiated based on the alpha character regardless of upper/lower case designation.
- A blank space appears between lower case characters and numeric characters. If the blank space is selected, the space bar on the PC keyboard will trigger data collection when pressed.

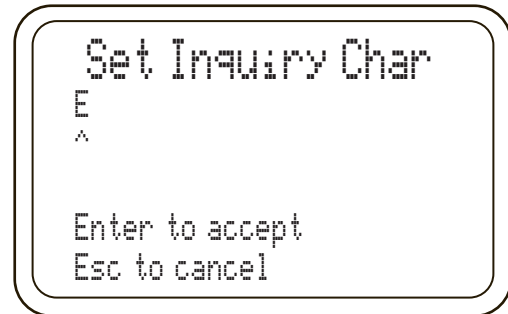
**HHC will revert to Measurement Mode.**

If the PC is set up with the terminal emulation program running and set to the proper COM port whenever the inquiry character is pressed an entry will be made

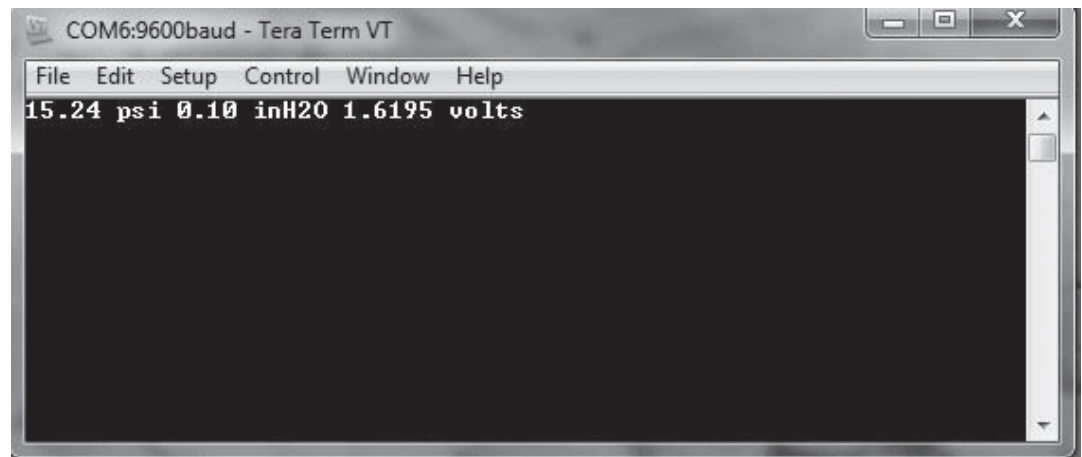

Set up Journal Mode

Journal mode is similar to Automatic Datalogging mode where the operator can set a timed interval between data points being communicated to the PC.

In Journal Mode the HHC will output the data string at a time interval set by the user. No command from the PC is needed to start the Journal output. The Journal mode output is started and stopped via the user from the keypad of the HHC

- Press MENU key
- Use DOWN or UP ARROW to highlight "Modes..."
- Press ENTER
- Use DOWN or UP ARROW to highlight "Communications ..."
- Press ENTER
- Use DOWN or UP ARROW to highlight "Journal/Inquiry..."
- Press ENTER
- Use DOWN or UP ARROW to highlight "Journal Interval..."
- Press ENTER
- Display will show "Journal interval"

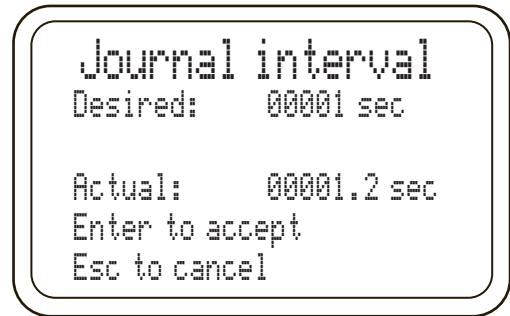

Note: maximum journal interval is 86400 seconds (24 hours)
Press left and RIGHT ARROWS to select desired numeric character.

Press UP and DOWN keys to increment values UP or DOWN.
When the desired interval is displayed Press ENTER to save.

NOTE

To begin or stop detecting journal data when in Journal/Inquiry menu use DOWN or UP ARROW to hilight "Journal Start/Stop". Press ENTER. When programming, the display will show "Desired" interval and "Actual" interval. Actual interval may not match the desired value. The minimum sample rate changes are based on the number of inputs installed in the base unit. The sample rate increase 0.1 seconds per input (0.1, 0.2 or 0.3 seconds). The actual interval must be an even multiple of this value. For example if there are two pressure modules and a voltage input active, the minimum sample rate is 0.3 seconds or even multiples of 0.3 seconds. If the desired value entered is 1 second the actual value will remain 1.2 seconds.

ISO1745

Refer to section 16c for protocol definition and commands.

HHC Base Unit Field Calibration

The HHC base unit can be recalibrated and certified in the field. The procedure allows for the acquisition of "as found" and "as left" data, and recalibration of the base unit.

Field calibration typically consists of three steps. Step one is to document the "as found" or pre calibration condition of the HHC. Step two is to perform the recalibration procedure to adjust coefficients used by the HHC. Step 3 is to repeat step one to document the "as left" or post recalibration condition of the HHC.

The procedure details three processes, first obtaining "as found" and second performing the actual calibration of the HHC, and third obtaining "as left" data..

Obtaining “As found” and “As Left” data procedure consists of applying precision voltage and current signals to the proper terminations and reading the values displayed on the HHC display.

Base unit recalibration is a firmware based, menu driven procedure that provides prompts on the HHC display directing the operator to apply precision voltage and current signals to designated terminals. Recalibration is accessed via the menu system.

Calibration Function Password

HHC calibration functions are password protected. The passwords may be obtained by contacting the factory or downloading the “HHC Secure” application from the web site. “HHC Secure” will generate the HHC’s unique pass codes based on user input of the base unit serial number. Make a note of these pass codes

The base unit serial number is needed to determine the password. To locate the serial number label remove any installed pressure modules, hold the base unit keypad side down and look into the module bays. The serial number is also displayed briefly during HHC base unit power up. The label is located on the underside of the keypad/front panel section of the base unit.

Calibration Equipment Required

In order to perform HHC base unit verification and recalibration a precision voltage and current standard is required. To maintain specified accuracy of the HHC base unit, the calibration standard must exceed the base unit accuracy specification four times the specification of the HHC base unit. The voltage and current standard is needed both for documenting calibration data as well as the recalibration procedure,

The instrument must be capable of providing resolution and accuracy at least to the following levels;

- SENSOR MODULE INPUT 0 to + 1.00000 ±20uv DC (0.00002 volt) (required accuracy ±.005%)
- 10 VOLT CALIBRATION 0 to +10.000 ±625uv DC (0.000625 volt) (stated accuracy ±.025%)
- 30 VOLT CALIBRATION 0 TO 30.000 ±7.50mv DC (0.0075 volt)(stated accuracy ±.1%)
- 20 ma CALIBRATION 0 to 20.000 ± 1.5ua (0.0000015 amp) DC (stated accuracy ±.03%)

Required Equipment Calibration Module part number 312D224-01

HHC Base Unit Documenting Calibration Data (As Found and As Left Data)

Documenting the condition of the HHC before and after it is recalibrated (“As Found” and “As Left”) follows the same procedure. The operator will verify and document the accuracy of the DC voltage input, the DC current input and the Channel 1 module input.

The number of points verified when documenting calibration data varies based on customer requirements. At minimum zero and full scale values should be documented. Calibration data must be manually collected and documented. The HHC does not log its own calibration data.

Documenting Calibration Data Procedure

NOTE: The input jacks for the 10 and 30 volt inputs are the same input jacks, the accuracy statement for 10 volts is for values between 0 and 10 volts DC, the accuracy statement for 30 volts DC is for values above 10 volts to 30 volts DC

VOLTAGE JACK INPUT, 0-10 volts

1. Connect the negative lead of the voltage standard to the black ringed “COM” input jack



2. Connect the positive lead of the voltage standard to the red ringed "0-33Vdc In" jack
3. Power on a voltage standard capable of delivering up to 10.000v DC and allow it to warm up to its specified accuracy as defined by the manufacturer
4. Power on the HHC using either USB or battery power and allow it warm up to its specified accuracy (5 minutes)
5. Set the voltage standard to 0.000 volts dc
6. With the HHC in measure mode press the Ma/V key repeatedly until a voltage reading appears on the display
7. Make note of the voltage standard input voltage and the voltage value displayed on the HHC display.
8. Verify that displayed voltage is within ± 2.0 mV (± 0.0020 volt)
9. Increase the input voltage setting from the voltage standard at desired intervals until reaching 10.000 volts.
10. Note input standard voltages and HHC displayed voltages and calculate error.
11. It is recommended to at minimum verify display voltage at 0.000 and 10.000 volts input.
12. When test is complete, set voltage standard to 0.00 volts and disconnect the leads from the HHC.

VOLTAGE JACK INPUT, 10-30 volts

1. Connect the negative lead of the voltage standard to the black ringed "COM" input jack
2. Connect the positive lead of the voltage standard to the red ringed "0-33Vdc In" jack
3. Power on a voltage standard capable of delivering up to 30.000v DC and allow it to warm up to its specified accuracy as defined by the manufacturer
4. Power on the HHC using either USB or battery power and allow it warm up to its specified accuracy (5 minutes)
5. Set the voltage standard to 10.000 volts dc
6. With the HHC in measure mode press the mA/V key repeatedly until a voltage reading appears on the display
7. Make note of the voltage standard input voltage and the voltage value displayed on the HHC display.
8. Verify that displayed voltage is within ± 30 mV (± 0.03 volt)
9. Increase the input voltage setting from the voltage standard at desired intervals until reaching 30.000 volts.
10. Note input standard voltages and HHC displayed voltages and calculate error.
11. It is recommended to at minimum verify display voltage at 10.00 and 30.00 volts input.
12. When test is complete, set voltage standard to 0.00 volts and disconnect the leads from the HHC.

CURRENT JACK INPUT

1. Connect the negative lead of the current source to the black ringed "COM" input jack
2. Connect the positive lead of the current source to the red ringed "0-22mA In" jack

3. Power on a DC current source capable of delivering up to 20.000mA and allow it to warm up to its specified accuracy as defined by the manufacturer
4. Power on the HHC using either USB or battery power and allow it warm up to its specified accuracy (5 minutes)
5. Set the current source to 0.000 mA
6. With the HHC in measure mode press the Ma/V key repeatedly until a mA reading appears on the display
7. Make note of the current source input current mA value and the current mA value displayed on the HHC.
8. Verify that displayed current is within $\pm 6\mu\text{A}$ (± 0.006 mA)
9. Increase the input current setting from the current source at desired intervals until reaching 20.000 mA.
10. Note input standard current and HHC displayed current and calculate error.
11. It is recommended to at minimum verify display current at 0.000 and 20.000 mA input.
12. When test is complete, set current source to 0.00 mA and disconnect the leads from the HHC.

SENSOR MODULE INPUT, 0 to +1.00000 V

WARNING Applying more than 1.25 volts to the calibration module input could cause damage to the input of the HHC

NOTE Sensor Module Calibration verification is performed through Channel 1 module bay. Calibration values for both module bays are verified and programmed via Channel 1. Functionality of Channel 2 bay is verified by installing a pressure or temperature module.

NOTE Any module inserted into the CH2 module bay during this procedure could interfere with the resolution of the voltage reading coming from the calibration module.

NOTE If this process is performed following System Field Calibration, damping is automatically set to 16 (maximum.). To reduce the damping level to 1 (minimum), power cycle the HHC prior to reading "As Left" data.

NOTE The HHC will not recognize the calibration module as a pressure or temperature module.

1. Remove any pressure or temperature modules from both system module bays.
2. Insert the Calibration Module into the Channel 1 module bay.
3. Leave Channel 2 bay empty or insert a system protection module.
4. Turn on the precision voltage standard and allow it to warm up to its stated accuracy
5. Set the voltage standard to a range to generate 0.00000v
6. Connect the negative lead of the voltage source to the black terminal on the Calibration Module
7. Connect the positive lead of the voltage source to the red terminal on the Calibration Module
8. Power on the HHC using either USB or battery power and allow it warm up to its specified accuracy (5 minutes)



9. Select Volts Engineering Units
 - a. Press MENU key
 - b. Press DOWN or UP ARROW key to highlight "Units..."
 - c. Press ENTER
 - d. Press DOWN or UP ARROW key to highlight "Select Units"
 - e. Press ENTER
 - f. Press DOWN or UP ARROW key to highlight "Channel 1 Module", "
 - g. Press ENTER
 - h. Press DOWN or UP ARROW key to highlight volts
 - i. Press ENTER
10. Voltage displayed on Channel 1 is the compensated 0-1 volt signal. Record this "As Found/Left" value.
11. Verify that displayed voltage is within $\pm 50\mu\text{V}$ (0.00005 Volt) of the voltage standard
12. Increase the input voltage setting from the voltage standard at desired intervals until reaching 1.00000 volts.
13. Note input standard voltages and HHC displayed voltages and calculate error.
14. It is recommended to at minimum verify display voltage at 0.00000 and 1.00000 volts input.
15. When test is complete, set voltage standard to 0.000 volts and disconnect the leads from the HHC.
16. To Exit voltage display mode, remove the Calibration Module and install a pressure or temperature measurement module into either bay or by cycling power to the HHC
17. This completes the "As found" or "As Left" Calibration check

HHC Base Unit Field Calibration Procedure

Base unit recalibration is a firmware based, menu driven procedure that provides prompts on the HHC display directing the operator to apply precision voltage and current signals to designated terminals. Recalibration is accessed via the menu system.

Flip Screen Function is not applicable in Calibration Mode.

1. Remove any pressure or temperature modules from both system module bays.
2. Insert the Calibration Module (312D224-01) into the Channel 1 module bay.
3. Leave Channel 2 bay empty or insert a system protection module.
4. Turn on the precision voltage standard and allow it to warm up to its stated accuracy
5. Set the voltage standard to a range to generate 0.00000v
6. Connect the negative lead of the voltage source to the black terminal on the Calibration Module
7. Connect the positive lead of the voltage source to the red terminal on the Calibration Module
8. Power on the HHC using either USB or battery power and allow it warm up to its specified accuracy (5 minutes)
9. Enter the Calibration Process via the Setup menu:
 - a. Press MENU key
 - b. Press DOWN or UP ARROW key to highlight "Setup..."
 - c. Press ENTER
 - d. Press DOWN or UP ARROW key to highlight "Calibrate"
 - e. Press ENTER

Cal Password screen appears. Enter Calibration Password

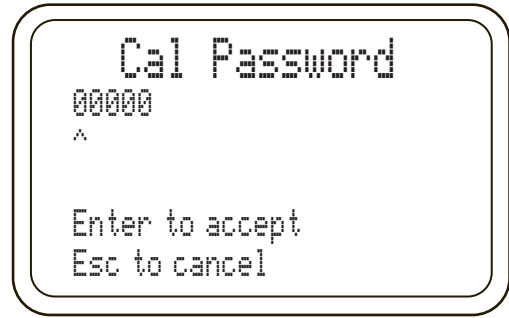

- f. Press left and RIGHT ARROWS to position cursor beneath desired character
- g. Press UP and DOWN ARROWS to increment numeric characters
- h. When the password is correct press ENTER
- i. "Calibrate" screen appears

Note: If the incorrect password is entered, the HHC display will show a message "Bad Cal PW", and the user will be asked to Retry or Abort.

- j. Press DOWN or UP ARROW key to highlight "System"
 - k. Press ENTER
 - l. "System Cal Ch1" screen appears
 - m. Press DOWN or UP ARROW key to highlight "Begin Base Cal"
 - n. Press ENTER
10. The HHC Base Unit will now begin prompting the operator to apply precision voltage values to specific terminals, data collection will take a few seconds then the HHC will prompt the operator to move to the next step in the following sequence :
- a. Apply 0.00000 volts to calibration module press ENTER
 - b. Apply 1.00000 volts to calibration module press ENTER
- WARNING: Applying more than 1.25 volts to the calibration module input could cause damage to the input of the HHC
- 11. When Prompted, set the voltage standard to 0.000 volts then
 - 12. POWER DOWN THE VOLTAGE STANDARD AND DISCONNECT THE VOLTAGE STANDARD FROM THE CALIBRATION MODULE
 - 13. Connect the negative lead of the voltage standard capable of delivering up to 10.000v DC to the black ringed "COM" input jack
 - 14. Connect the positive lead of the voltage standard to the red ringed "0-33Vdc In" jack
 - 15. Power on a voltage standard and allow it to warm up to its specified accuracy as defined by the manufacturer.
 - 16. The HHC Base Unit will prompt the operator to apply precision voltage values to specific terminals, data collection will take a few seconds then the HHC will prompt the operator to move to the next step in the following sequence :
 - a. Apply 0.000 volts to the voltage input jacks press ENTER
 - b. Apply 10.000 volts to the voltage input jacks press ENTER
 - 17. If using a different voltage standard for 0-30 volt calibration: POWER DOWN THE VOLTAGE STANDARD AND DISCONNECT INPUT TERMINALS
 - 18. Connect the negative lead of the voltage standard capable of delivering up to 30.000v DC to the black ringed "COM" input jack
 - 19. Connect the positive lead of the voltage standard to the red ringed "0-33Vdc In" jack

SECTION 15 n.

CALIBRATE BASE UNIT CONT.

20. Power on the voltage standard and allow it to warm up to its specified accuracy as defined by the manufacturer.
21. The HHC Base Unit will prompt the operator to apply precision voltage and current values to specific terminals, data collection will take a few seconds then the HHC will prompt the operator to move to the next step in the following sequence :
 - a. Apply 0.000 volts to the voltage input jacks press ENTER
 - b. Apply 30.000 volts to the voltage input jacks press ENTER
22. POWER DOWN THE VOLTAGE STANDARD AND DISCONNECT THE VOLTAGE STANDARD FROM THE VOLTAGE INPUT TERMINALS
23. Connect the negative lead of the current source to the black ringed "COM" input jack
24. Connect the positive lead of the current source to the red ringed "0-22mA In" jack
25. Power on the DC current source capable of delivering up to 20.000mA and allow it to warm up to its specified accuracy as defined by the manufacturer
26. The HHC Base Unit will prompt the operator to apply precision current values to specific terminals, data collection will take a few seconds then the HHC will prompt the operator to move to the next step in the following sequence :
 - a. Apply 0.000 mA to the current input jacks press ENTER
 - b. Apply 20.000 mA to the current input jacks press ENTER
27. This is the final data taking process of system field calibration. It is now necessary to save the newly calculated coefficients.
28. POWER DOWN THE CURRENT STANDARD AND DISCONNECT FROM THE INPUT TERMINALS
NOTE: If you wish to abort this process and not change the present calibration coefficients, press "ESC" and then "MENU" to return to the main menu
29. The HHC Base will prompt the operator to apply the calibration data .
30. Press "ENTER" and the calibration data will be saved to system EEPROM. A message will appear on the screen as the data is written to memory
31. Field Calibration is now complete.
32. If desired repeat the "As Found" procedure to document "As Left" data.

SECTION 15 o.

PRESSURE MODULE CALIBRATION

Pressure modules can be recalibrated and certified in the field. The procedure allows for the acquisition of "as found" and "as left" data, and recalibration of the pressure module.

Field calibration typically consists of three steps. Step one is to document the "as found" or pre calibration condition of the module. Step two is to perform the recalibration procedure to adjust coefficients used by the module. Step 3 is to repeat step one to document the "as left" or post recalibration condition of the module.

The procedure details two processes, first obtaining "as found" and "as left" data; second performing the actual calibration of the HHC.

Obtaining "As found" and "As Left" data consists of applying precisely controlled pressure to the module and comparing the value shown on the display to that being applied by the pressure standard. The number of points measured typically increases with the accuracy of the module. Factory calibration consists of the following number of points based on module accuracy:

- 0.025% & 0.05% enhanced accuracy
- 20 points (approximately 10% increment)

**PRESSURE MODULE CALIBRATION
CONT.**

- 0.025% - 0.07% standard accuracy
11 points (approximately 10% increment)
- 0.1% standard accuracy
6 points (approximately 20% increment)
- 0.25% standard accuracy
5 points (approximately 25% increment)

When calibrating linearity, the HHC will automatically choose the number and pressure value of data points based on the module's full scale pressure range and it's base accuracy specification.

Pressure module recalibration is a firmware based, menu driven procedure that provides prompts on the HHC display directing the operator to apply precision pressure at zero, full scale and several cardinal points, the quantity of which is determined by the accuracy specification of the module. Module recalibration is accessed via the menu system.

NOTE Following Pressure Module Calibration, damping is automatically set to 16 (maximum.). To reduce the damping level to 1 (minimum), power cycle the HHC, or remove and reinstall the pressure module.

REQUIRED EQUIPMENT

A Precision Pressure standard must be used to maintain the stated accuracy of the pressure module. It is recommended to have the pressure standard accuracy 4 times better, than the accuracy of the calibrated module.

PRESSURE MODULE FIELD CALIBRATION PROCEDURE

1. Insert Pressure Module to be calibrated into the CH 1 Module bay (left bay, when the HHC faces the operator with module bays up).
2. Turn the base unit on by pressing the green "ON/OFF" button on the keypad
3. Initiate the calibration process as follows:
 - a. Press MENU key
 - b. Press DOWN or UP ARROW key to highlight "Setup..."
 - c. Press ENTER
 - d. Press DOWN or UP ARROW key to highlight "Calibrate"
 - e. Press ENTER
Cal Password screen appears. Enter Calibration Password



- f. Press left and RIGHT ARROWS to position cursor beneath desired character
- g. Press UP and DOWN ARROWS to increment numeric characters
- h. When the password is correct press ENTER
- i. "Calibrate" screen appears
Note: If the incorrect password is entered, the HHC display will show a message "Bad Cal PW", and the user will be asked to Retry or Abort.
- j. Press DOWN or UP ARROW key to highlight "Pressure Module..."
- k. Press ENTER
- l. "Pres Mod CH1 Cal" screen appears



**PRESSURE MODULE CALIBRATION
CONT.**

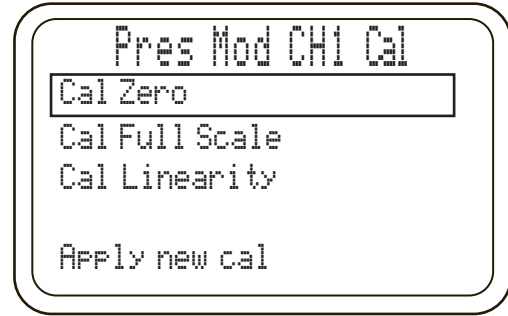

NOTE: Cal Zero function must be performed prior to proceeding to Cal Full Scale; Cal Zero & Cal Full Scale functions must be performed prior to proceeding to Cal Linearity. The “Cal Full Scale” & the “Cal Linearity” keys are activated only when this sequence is observed. The “Apply New Cal” function can be performed after each individual calibration steps (Zero, Full Scale, Linearity) was completed.

4. Select “Cal Zero” and Press “ENTER”,
 - a. The display will show target Zero pressure (00.00000).

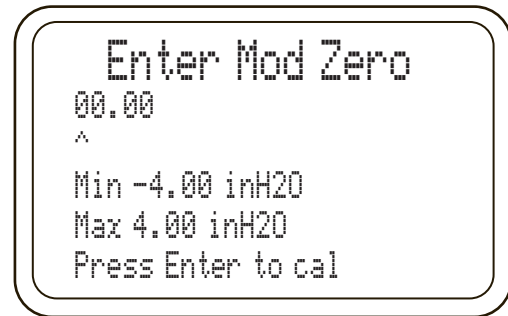

Note: Min and Max allowable limits for all calibration pressure values will be displayed below the target cardinal value. If the pressure standard does not achieve exactly the target cardinal pressure value, actual target pressure can be edited within the Min and Max limits. This value is the pressure reading which is displayed on the external pressure calibration standard.

The following is defined as “Zero Pressure” for various pressure types:

- Absolute Absolute Zero (using vacuum pump)
- Gauge Open to atmosphere (vent)
- Compound Open to atmosphere (vent)
- Differential Open both ports to atmosphere (vent)
- Vacuum Open to atmosphere (vent)

If the cardinal zero value cannot be achieved exactly by the pressure standard:

- b. Press left and RIGHT ARROWS to position cursor beneath desired character
- c. Press UP and DOWN ARROWS to increment numeric characters
- d. When the pressure value displayed on HHC matches value displayed on pressure standard press ENTER

The display will read “Acquiring Cal Data...Wait while system is busy”. After Zero Cal is complete (several seconds) the screen returns to the Calibration Menu with “Cal Full Scale” selected. At this time the operator can proceed with “Cal Full Scale”, return to “Zero Cal” to repeat application of zero pressure or save the Zero Cal by selecting “Apply new cal” and pressing “ENTER”.

5. Select “Cal Full Scale” and press “ENTER”.

**PRESSURE MODULE CALIBRATION
CONT.**

The target Full Scale Pressure cardinal value and Min and Max allowable limits will be displayed.

Use a pressure standard to apply target pressure value to a pressure module. If the pressure standard does not achieve exactly the target cardinal pressure value, actual target pressure can be edited within the Min and Max limits. This value is the pressure reading which is displayed on the external pressure calibration standard.

If the cardinal Full Scale Pressure value cannot be achieved exactly by the pressure standard:

- a. Press left and RIGHT ARROWS to position cursor beneath desired character
- b. Press UP and DOWN ARROWS to increment numeric characters
- c. When the pressure value displayed on HHC matches the value displayed on the pressure standard press ENTER

The display will read "Acquiring Cal Data...Wait while system is busy". After Full Scale Cal is complete (several seconds) the screen returns to the Calibration Menu with "Cal Linearity" selected. At this time the operator can proceed with "Cal Linearity", return to "Zero Cal", or "Cal Full Scale", or save the Zero Cal & Full Scale Cal by selecting "Apply new cal" and pressing "ENTER".

6. Select "Cal Linearity" and press "ENTER".

When calibrating linearity, the HHC will automatically choose the number and pressure value of data points based on the module's full scale pressure range and its base accuracy specification. The number of equidistant pressure values required for linearity calibration is listed below:

- 0.025% & 0.05% enhanced accuracy
20 points (approximately 10% increment)
- 0.025% - 0.07% standard accuracy
11 points (approximately 10% increment)
- 0.1% standard accuracy
6 points (approximately 20% increment)
- 0.25% standard accuracy
5 points (approximately 25% increment)

The first linearization point target pressure and min and max allowable limits in default engineering units will be displayed. Using the pressure standard, apply the target pressure to the module. If the pressure standard does not achieve exactly the target cardinal pressure value, actual target pressure can be edited within the Min and Max limits. Actual value is the pressure reading which is displayed on the external pressure calibration standard.

If the cardinal linearization pressure value cannot be achieved exactly by the pressure standard:

- a. Press left and RIGHT ARROWS to position cursor beneath desired character
- b. Press UP and DOWN ARROWS to increment numeric characters

7. When the pressure value displayed on HHC matches the value displayed on the pressure standard press ENTER" The system will respond with "Acquiring Cal Data...Wait while system is busy".

NOTE: The first linearization point pressure is equivalent to the first pressure point after Zero for all pressure types, except Compound. For the Compound ranges, the first calibration point will be an equivalent to the lowest negative pressure of the range.

Upon completion of the first calibration point inquiry, the HHC will respond with a next calibration point screen and continue through the process until the last calibration point is complete. The last calibration point will be a pressure point one step before the Full Scale pressure. Repeat steps 6 and 7 as many times as required based on accuracy as noted above.



**PRESSURE MODULE CALIBRATION
CONT.**



8. Upon completion of the Linearization process, the HHC will prompt "Apply new cal" function to save the results of the entire procedure. Also at this time, each individual component of calibration (Cal Zero, Cal Full Scale & Cal Linearity) can be returned to, redone and saved individually.
9. To proceed with saving the entire Calibration, press "ENTER". The system will display: "Saving Parameters. This will take a few seconds" and then return to the Pressure Measuring Screen.

10. The pressure module field calibration process is complete.

NOTE: If the field calibration process needs to be interrupted, use the ESC key to revert back to a previous step in the procedure. Several sequential ESC commands will return the system to a pressure-measuring mode. This will work in any part of the process, except when the data is being acquired.

The data inquiry can be aborted by pressing the MENU key – this will return the system back to the MAIN MENU screen.

New calibration data is being saved to the module EEPROM only when the "Apply new cal" function is performed. If this was not done during the field calibration process – the system will have no permanent changes. As soon as the power is recycled, the unit will return to "pre-calibration" state.

The "Cal Linearity" procedure must be completed in its entirety (all linearity points have to be taken) in order to save new linearity corrections. If during "Cal Linearity" procedure the ESC key was pressed before all linearity points were taken, the partial linearization data will be discarded.

Multiply By From To	psi	kg/cm ²	kPa	MPa	bar	mbar	inH ₂ O (4°C)	inH ₂ O (20°C)	inH ₂ O (60°F)	cmH ₂ O (4°C)	cmH ₂ O (20°C)	cmH ₂ O (60°F)	mmH ₂ O (4°C)	mmH ₂ O (20°C)	mmH ₂ O (60°F)	inHg (0°C)	mmHg (0°C) or Torr	ftSW
psi	1	0.070307	6.894757	0.006895	0.068948	68.94757	27.68067	27.72925	27.70759	703.0889	70.4323	70.37728	70.30889	7.04323	7.037728	2.03602	51.71492	2.245677
kg/cm ²	14.22334	1	98.0665	0.098067	0.980665	980.665	393.7117	394.4027	394.0946	10000.28	1001.783	1001	1000.028	100.1783	100.1	28.95902	735.5591	31.94104
kPa	0.145038	0.010197	1	0.001	0.01	10	4.014742	4.021788	4.018647	101.9744	10.21534	10.20736	10.19744	1.021534	1.020736	0.2953	7.500615	0.325708
MPa	145.0377	10.19716	1000	1	10	10000	4014.742	4021.788	4018.647	101974.4	10215.34	10207.36	10197.44	1021.534	1020.736	295.2998	7500.615	325.7079
bar	14.50377	1.019716	100	0.1	1	1000	401.4742	402.1788	401.8647	10197.44	1021.534	1020.736	1019.744	102.1534	102.0736	29.52998	750.0615	32.57079
mbar	0.014504	0.00102	0.1	0.0001	0.001	1	0.401474	0.402179	0.401865	10.19744	1.021534	1.020736	1.019744	0.102153	0.102074	0.02953	0.750062	0.032571
inH ₂ O (4°C; 39.2°F)	0.036126	0.00254	0.249082	0.000249	0.002491	2.49082	1	1.001755	1.000973	25.39999	2.544458	2.54247	2.539999	0.254446	0.254247	0.073554	1.868268	0.081128
inH ₂ O (20°C)	0.036063	0.002535	0.248646	0.000249	0.002486	2.486456	0.998248	1	0.999219	25.3555	2.54	2.538016	2.5355	0.254	0.253802	0.073425	1.864995	0.080986
inH ₂ O (60°F)	0.036091	0.002537	0.24884	0.000249	0.002488	2.4884	0.999028	1.000782	1	25.37532	2.541986	2.54	2.537532	0.254199	0.254	0.073482	1.866453	0.081049
cmH ₂ O (4°C; 39.2°F)	0.001422	0.0001	0.009806	0.0000981	0.000981	0.98064	0.03937	0.039439	0.039408	1	0.100176	0.100097	0.1	0.010018	0.01001	0.002896	0.073554	0.003194
cmH ₂ O (20°C)	0.014198	0.00098	0.097892	0.000979	0.000979	0.97892	0.393011	0.393701	0.393393	9.982478	1	0.999219	0.998248	0.1	0.099922	0.028907	0.73425	0.031884
cmH ₂ O (60°F)	0.014209	0.00099	0.097969	0.00098	0.00098	0.979685	0.393318	0.394009	0.393701	9.990282	1.000782	1	0.999028	0.100078	0.1	0.02893	0.734824	0.031909
mmH ₂ O (4°C; 39.2°F)	0.014223	0.001	0.098064	0.000981	0.000981	0.980638	0.393701	0.394392	0.394084	10	1.001755	1.000973	1	0.100176	0.100097	0.028958	0.735539	0.03194
mmH ₂ O (20°C)	0.14198	0.009982	0.97892	0.00979	0.009789	9.789198	3.93011	3.937008	3.933933	99.82478	10	9.992189	9.982478	1	0.999219	0.289075	7.3425	0.318842
mmH ₂ O (60°F)	0.142091	0.00999	0.979685	0.00998	0.009797	9.79685	3.933183	3.940086	3.937008	99.90282	10.00782	10	9.990282	1.000782	1	0.289301	7.34824	0.319091
inHg (0°C)	0.491154	0.034532	3.386389	0.003386	0.033864	33.86389	13.59548	13.61934	13.6087	345.3251	34.59312	34.5661	34.53251	3.459312	3.45661	1	25.4	1.102974
mmHg (0°C) or Torr	0.019337	0.00136	0.133322	0.000133	0.001333	1.333224	0.535255	0.536194	0.535776	13.59548	1.361934	1.36087	1.359548	0.136193	0.136087	0.03937	1	0.043424
ftSW	0.4453	0.031308	3.070235	0.00307	0.030702	30.70235	12.3262	12.34784	12.33819	313.0855	31.3635	31.339	31.30855	3.13635	3.1339	0.90664	23.02865	1

Trouble Shooting and Error codes

UNIT WILL NOT POWER UP ON BATTERIES

Verify batteries (quantity 4, size AA) are fresh and that they are placed in the battery holder in the correct direction, matching the polarity shown on the battery holder, and that they are properly seated. For Intrinsically Safe approved units the batteries are required to be DURACELL MN1500 type.

If fresh batteries are installed and properly seated into the battery holder and does not solve the problem, consult the factory.

To isolate the battery circuit, power the unit via the USB cable powered from either the power supply or the port of a PC or power supply. Continue on to the following section if the unit still won't power up:

UNIT WILL NOT POWER UP VIA USB CONNECTOR

WALL SUPPLY

Ensure that the wall supply is inserted all the way into the wall socket

Verify that that the AC wall socket is of the proper AC voltage for the wall supply

Verify that the wall supply is working properly by trying another wall supply if available or power another USB device.

USB PORT

Plug the PTE-2 into the USB port of a PC. If the unit fails to power up either the USB port is faulty, the cable is bad, or the HHC has failed. Consult the factory.

UNIT WILL NOT COMMUNICATE TO A PC via USB cable

Ensure the connector being used to connect to the HHC is a "Micro B" connector and that the connector used to connect to the PC port is a standard USB "A" connector.

Ensure both connectors are firmly seated into their respective female sockets at the HHC and the PC

When plugging the HHC into the PC listen for the "enumeration" sound coming from the PC , if there isn't an enumeration sound either the PC port is faulty or there is a failure inside the HHC. Try another USB port on the PC, if using a PC with both front and rear USB ports try both the front and the rear ports

Look for the USB trident icon on the HHC display, if it is there then the USB system has been properly enumerated

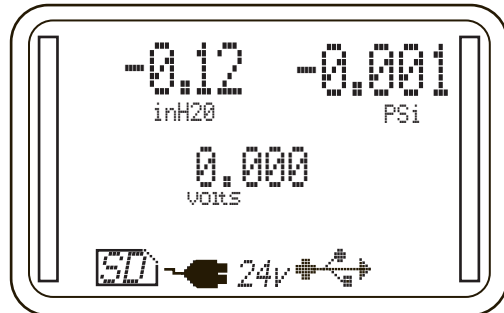

If communication to the PC is still faulty refer to the manual for the proper set up of all drivers and software on the PC.

If issues still persist, consult the factory

UNIT WILL NOT DELIVER 24Vdc LOOP SUPPLY OUTPUT

If the HHC is an Intrinsically Safe base unit, then loop supply is not available.

Reference the manual section 14k to enable and disable the power supply. Attempt to enable the supply. Ensure that the "24V" icon appears on the display of the HHC.

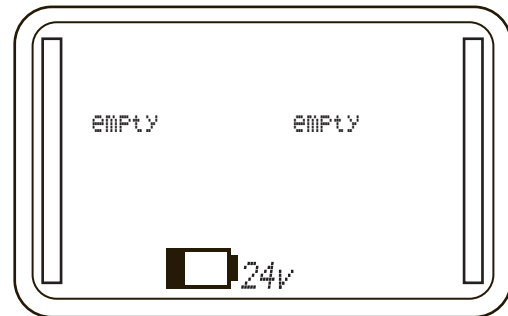

If the power supply has been overloaded and a warning message shows on the display (supply current is specified at 35ma and will overload at approximately 54-55ma)

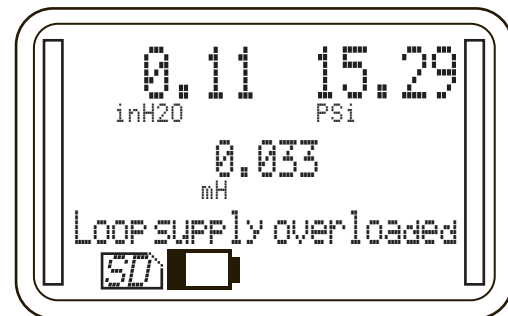

Remove the overload from test circuit and enable the 24 VDC power supply via MENU commands. (See section 14k)

Ensure that the supply is being measured between the "24Vdc Out" jack and the "COM" output jack at the top of the HHC.

Check all connections and wires in the set up to ensure continuity if not working;

Remove all system wires connected to the HHC jacks at the top of the unit and place a volt meter directly across the "24Vdc Out" (+) and the "COM" (-) jacks, and measure the output. If the icon is on the display and the 24Vdc output is there ($24V \pm .5$ volts) then the HHC is operational and the system set up is faulty. Check the set up. If the loop supply output is still non-operational consult the factory.

DATALOG WILL NOT EXPORT TO THE SD CARD

Ensure that the internal datalog memory has a datalog loaded into it (see section 15f vi. Review Datalogs). If there are no stored datalogs, the HHC will display an error message .

Verify that SD card write protect lock is off.

Ensure that the SD card is fully inserted into the onboard connector of the HHC.

The SD card may be faulty, change the SD card

In order to ensure compatibility with the majority of manufacturers, the PTE-2 was developed using a number of different types of SD cards try using one of these recommended SD cards. (See section 16g)

Refer to the manual and repeat steps required to export data.

If the HHC still displays an error message, consult the factory.

WILL NOT READ VOLTAGES ON ITS “0-33Vdc In” INPUT JACK

Consult the suggested wiring diagrams in section 14j referring to the proper voltage measurement setup

With the unit powered up ensure that the input voltage is selected from the front keypad (refer to manual) by pressing the “mA/V” key in the lower left hand corner of the key pad. Multiple presses of the key will rotate through “Volts”, “mA”, and pressure only (blank displayed in the middle of the LCD display). If voltage still isn’t displayed when selected:

Remove the HHC from the external wiring system and connect a DC voltage source (0-33 Volts DC Max) between the “0-33Vdc In” jack (+) and the “COM” jack (-) located at the top of the unit. Select “volts” using the front keypad “ma/V” key and monitor the display. The input voltage should be displayed.

If the voltage source used is faulty you can use the 24 volt loop supply of the HHC to check the input voltage jack. Ensure that the loop supply is operational (only valid for non- I.S. units) _ connect the “24Vdc Out” jack to the “0-33Vdc In” jack and read the voltage on the display _ Note that the COM connection is not required here as they share this connection internally to the PTE-2.

Note: The power supply of a non-intrinsically safe base unit exhibits a leakage voltage of approximately 1 volt in the off condition. This is normal.

If the voltage still cannot be read, consult the factory

WILL NOT READ CURRENT INPUT INTO THE “0-22Ma In” JACK

Consult the manual’s circuit diagram section 14j, referring to the proper current measurement setup

With the unit powered up ensure that the input current measurement is selected from the keypad by pressing the “mA/V” key in the lower left hand corner of the key pad. Multiple presses of the key will rotate through “Volts”, “mA”, and pressure only (blank displayed in the middle of the LCD display). If current still isn’t displayed when selected:

Remove the HHC from the external system and connect an isolated direct current source (0-22 mA Max) between the “0-22mA In” jack (+) and the “COM” jack(-) located at the top of the unit. Select “mA” using the keypad “mA/V” key and monitor the display. The input current should be displayed, if the current is not displayed:

Using a precision voltage source input a 200mv signal (+) positive lead into the “0-22mA In” jack and the negative side of the voltage source (-) to the “COM” jack. This will simulate a 20ma signal. If the current still is not displayed consult the factory

WILL NOT DISPLAY PRESSURE MODULE DATA

Remove the module from the base unit and then re-install the module making sure it is fully seated in its base unit cavity. The modules are hot swappable and upon reinsertion the pressure should be displayed after the units re-booting process. If no pressure value is displayed:

Turn off power to the HHC by pressing the green power key. Remove the pressure module in question. Look into the vacated module cavity in the base unit and inspect the interface connector pins inside the cavity. Ensure that none of the connector pins are bent or damaged. In the unlikely event one or more of the pins are bent, carefully straighten the pin(s) then re- insert the module making sure that the locking tab is fully seated in its mating hole at the bottom of the base unit. Turn the base unit back on, pressure should be displayed after the units booting process. If pressure is not displayed, try another pressure module if

available. If the 2nd module functions properly consult the factory about the faulty module if both modules fail consult the factory regarding the HHC base unit.

WILL NOT DISPLAY TEMPERATURE MODULE DATA

For both Thermocouple and RTD modules, ensure that the module is connected to either a thermocouple or RTD probe and that the sections of the manual relating to their set up has been observed .

Follow the procedure for lack of pressure module readings under “HHC WILL NOT DISPLAY PRESSURE MODULE DATA” above

SYSTEM ERROR MESSAGES

Internal Operating System Error Messages

If any of the following messages are displayed Reset the power off and back on.

If cycling power does not resolve the issue, note the sequence of operations performed before the error message appeared and contact customer service.

Error message list:

- *Operation timed out triggering self-protection reset*
- *Failed to create internal message queue*
- *Nonexistent notice or error message received*
- *A system error occurred, and the error message was corrupted*
- *Failed to initialize display subsystem*
- *Failed to initialize ADC subsystem*
- *Failed to initialize module subsystem*
- *Failed to initialize keypad subsystem*
- *Failed to initialize periodic checks subsystem*
- *Failed to initialize director subsystem*
- *Failed to initialize MENU subsystem*
- *Failed to initialize communications subsystem*
- *Failed to initialize datalog subsystem*
- *Stack overflow in error handling subsystem*
- *Stack overflow in display subsystem*
- *Stack overflow in ADC subsystem*
- *Stack overflow in module subsystem*
- *Stack overflow in keypad subsystem*
- *Stack overflow in periodic checks subsystem*
- *Stack overflow in director subsystem*
- *Stack overflow in MENU subsystem*
- *Stack overflow in communications subsystem*
- *Stack overflow in datalog subsystem*
- *Stack overflow in unknown subsystem*

Internal Hardware System Errors

- *Internal communication failure (I2C bus)*
- *Communication failure with module EEPROM*
Corrective action: Confirm Module(s) are inserted properly. Reset power off/on;
If problem persists contact customer service
- *ADC reference not within valid range*
- *ADC conversion timed out*
Corrective action: Reset power off/on, contact customer service
- *System EEPROM appears to be corrupted*
Corrective action: Reset power off/on, contact customer service

Hardware Warnings

- *CH1 F.S. INVALID/ CH2 F.S. INVALID:*

Danger, the PTE-2 may not display the full scale psi when applied (A legacy PTE-1 module with invalid output at full scale) Contact Customer Service

- *CH1 Low Span / CH2 Low Span*
Danger, the PTE-2 may not display the full scale psi when applied (A legacy PTE-1 module with invalid output at full scale) Contact Customer Service
- *Loop supply overloaded*: see troubleshooting section
- *Loop supply reset failed*: see troubleshooting section
- *FRAM write failed*: Contact customer service
- *FRAM read failed*: Contact customer service
- *Datalog corrupt*: Contact customer service
- *Datalog error corrected*: if warning reoccurs contact customer service
- *Can't read clock*: There is an issue with the internal real time clock,
- *Current date bad*: the real time used may not be accurate.
- *Failed to open file/ Failed to close file*: SD card failure, card may be bad or full

System Warnings

- *SYS not-calibrated*: The PTE-2 is not calibrated, contact customer service
- *Out of internal memory*: datalog memory is filled, transfer to SD Card and clear internal datalog to make room.
- *Out of datalog*: maximum number of datalogs reached, transfer to SD Card and clear internal datalog to make room.
- *Out of records*: present datalog can take no more records, start a new datalog.

Operation Warnings

- *CH1 zero out of bounds/ CH2 zero out of bounds*: input pressure is too high to be zeroed
- *CH1 not a pressure mod / CH2 not a pressure mod*: attempting to zero or tare a module which is not a pressure module
- *CH1 conversion invalid/ CH2 conversion invalid*: module range is not valid for Units selection
- *No SD card present*: Attempting to perform an SD card operation with non-installed SD card
- *SD card locked*: attempting to transfer to an SD card but the write protect tab is engaged.
- *No module to damp*: attempting to damp with no module present
- *Can't enter MENU (log)*: The MENU cannot be entered while datalogging, press the Esc key to halt a datalog when ready.

System Warnings

- *Low battery*: main battery is low, replace with four fresh AA alkaline batteries
- *RTC battery low*: Real time clock battery is near end of life. The battery needs to be replaced. This is not a field service item. Contact customer service.
- *Bad msg sent to display*: reset PTE-2, contact customer service

Percent Error Operation messages

- *% Err: in & out match*: refer to section
- *% Err: bad input range*: refer to section
- *% Err: bad output range*:
- *% Err: ext input of*: press V/mA key to turn external channel on
- *% Err: CH1 empty*: no module is installed in Channel 1 bay
- *% Err: CH2 empty*: no module is installed in Channel 2 bay

SECTION 16 b.

TROUBLE SHOOTING CONT.

Dual Sensor Operation messages

- *DS err: CH1 unplugged:* no module is installed in Channel 1 bay
- *DS err: CH2 unplugged:* no module is installed in Channel 2 bay
- *DS err: units mismatch:* engineering units of installed modules are different. Use units MENU to make both modules display same engineering units.

Switch Test Operation messages

- *ST err: CH1 unplugged:* no module is installed in Channel 1 bay
- *ST err: CH2 unplugged:* no module is installed in Channel 2 bay
- *Sw. Test forced V in:* Voltage input was not enabled prior to initiating switch test. The HHC has automatically enabled voltage input monitoring
- *Sw. Test forced mA in:* mA input was not enabled prior to initiating switch test. The HHC has automatically enabled mA input monitoring
- *No 24v loop (IS unit):*

SECTION 16 c.

ISO COMMANDS

Appendix C

ISO 1745 Commands

Format for command

ASCII non-printable	(hex) (hex)	Included in BCC = xor'd	
SOH	01		
DLE	10		
STX	02	Y	
<cmd>		Y	HHC command
DLE	10		
ETX	03	Y	
BCC			BCC = byte[2] ^ byte[3] ^ byte[5]

ASCII code	hex
SOH	01
DLE	10
STX	02
ETX	03
NAK	15
ACK	06

PTE-2 Response is the same format preceded by an ACK, a NACK is sent alone if the command is not understood.

Hex Code	Description	Command
23	Get datalog status	Returns the datalog information as an ASCII string
24	Go to the top of the next datalog	
25	Get datalog record	Returns the data for the present record in the present datalog as an ASCII string
26	Configure RTD module for calibration (CH1)	
27	Get datalog count	Returns the number of datalogs
31	Get CH1 unit*	Returns CH1 units index*
32	Get CH1 module reading	Returns an ASCII string representing the CH1 reading
36	Get CH2 units*	Returns CH2 units index*
38	Force channel to user units	Parameter <channel 0 = CH1, 1 = CH2>
7D	Loop power on off	Parameter 0 = off 1 = on
37	Get CH2 module reading	Returns an ASCII string representing CH2 reading

*Units Index for commands

Index	Units
0	psi
1	inH ₂ O
2	inHg
3	Kpa
4	mBar
5	cm H ₂ O
6	mmHg
7	<user>
8	ftSW
9	Bar
10	Mpa
11	mm H ₂ O
12	Kg/cm ²
13	Volts
20	Celsius
21	Fahrenheit
22	Kelvin
23	Rankine
24	Ohms

APPENDIX D
RTD PROBE CONNECTOR

SWITCHCRAFT TINI QG (TA4F)

PIN	FUNCTION
1	2W+
2	4W+
3	4W-
4	2W-

2 WIRE RTD

TA4F



3 WIRE RTD

TA4F

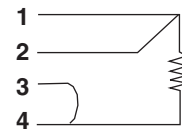

4 WIRE RTD

TA4F

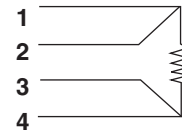

SYSTEM ACCURACY WITH THERMOCOUPLE INTERFACE

TABLE I

System Accuracy (reading in temperature units): Includes the HHC base unit and XXX interface module. *(Does not include inaccuracy of the thermocouple device. Consult thermocouple manufacturer or ISA MC96.1 for thermocouple accuracy specifications. Typical inaccuracies range from ±1 to ±2.2°C.)*

Thermocouple Type	Measurement Range (°C)	Accuracy @ 25°C Ambient (Not Including Internal Reference Junction) Expressed as ±°C	Accuracy @ 25°C Ambient (Including Internal Reference Junction) Expressed as ±°C	Max. additional error due to ambient temperature deviation from 25°C. Expressed as additional C error per each C deviation from 25°C
J	-210 to -151	0.7	1.1	0.02
	-150 to 1200	0.3	0.4	0.01
K	-240 to -201	1.5	2.2	0.05
	-200 to -101	1.0	1.5	0.03
	-100 to 999	0.5	0.8	0.02
T	-250 to -201	1.5	2.2	0.05
	-200 to -101	0.8	1.2	0.03
	-100 to 400	0.5	0.8	0.02
E	-250 to -201	1.2	2.0	0.04
	-200 to -101	0.6	1.1	0.02
	-100 to 400	0.3	0.6	0.01
R&S	-50 to 299	3.4	3.6	0.10
	300 to 1768	1.2	1.3	0.04
B	100 to 199	14.0	14.0	0.44
	200 to 499	5.0	5.0	0.16
	500 to 999	3.0	3.0	0.08
	1000 to 1820	1.2	1.2	0.04
N	-250 to -226	4.3	5.7	0.14
	-225 to -101	2.1	2.8	0.07
	-100 to 1300	1.0	1.4	0.02

Conversion Factors (to convert °C specifications to other units of measure):

To convert from °C to °F: $°F = (1.8 \times °C) + 32$

To convert from °C to °K: $°K = °C + 273.15$

To convert from °C to °R: $°R = (1.8 \times °C) + 427.67$

TABLE II

System Accuracy (based on direct millivolt reading from thermocouple – includes HHC base unit and XXX interface module. (Does not include inaccuracy due to the thermocouple device. Reference junction not applicable to direct millivolt readings.)

Input Range of	Accuracy @ 25°C	Max. additional error due to ambient temperature deviation from 25°C. Expressed as additional millivolt error per each °C deviation from 25°C
-10 to 100 millivolt	± 0.0125 millivolts	.001

APPROVED SD DATA CARDS

Sandisk 8GB Class 4 SDHC card, SKU SDSDB-8192-A11 . Other SD cards will work, provided they meet the following requirements:

1. 4GB to 32 GB SDHC card –or- 4GB to 32GB micro SD card with micro SD-to-SD adapter
2. Formatted to FAT32 or exFAT filesystem
3. Speed class 4 or higher
4. Write protection disabled

WARRANTY AND LIMITATION OF LIABILITY

WARRANTY INFORMATION

- A.** Seller warrants that its products and parts, when shipped, and its work (including installation, construction and start-up), when performed, will meet all applicable specifications and other specific product and work requirements (including those of performance), if any, of this agreement, will be of good quality and will be free from defects in material and workmanship. All claims under this warranty must be made in writing immediately upon discovery and, in any event, within one (1) year from shipment of the applicable item unless Seller specifically assumes installation, construction or start-up responsibility. All claims when Seller specifically assumes installation, construction or startup responsibility, must be made in writing immediately upon discovery and, in any event, within one (1) year from completion of the applicable work by Seller, provided, however all claims must be made in writing no later than eighteen (18) months after shipment. Defective items must be held for Seller's inspection and returned to the original f.o.b. point upon request. THE FOREGOING IS EXPRESSLY IN LIEU OF ALL OTHER WARRANTIES WHATSOEVER, EXPRESS, IMPLIED AND STATUTORY, INCLUDING, WITHOUT LIMITATION, THE IMPLIED WARRANTIES OF MERCHANTABILITY AND FITNESS.
- B.** Upon Buyer's submission of a claim as provided above and its substantiation, Seller shall at its option either (i) repair or replace its product, part of work at the original f.o.b. point of delivery or (ii) refund an equitable portion of the purchase price.
- C.** THE FOREGOING IS SELLER'S ONLY OBLIGATION AND BUYER'S EXCLUSIVE REMEDY FOR BREACH OF WARRANTY AND, EXCEPT FOR GROSS NEGLIGENCE OR WILLFUL MISCONDUCT. THE FOREGOING IS BUYER'S EXCLUSIVE REMEDY AGAINST SELLER FOR ALL CLAIMS ARISING HEREUNDER OR RELATING HERETO WHETHER SUCH CLAIMS ARE BASED ON BREACH OF CONTRACT, TORT (INCLUDING NEGLIGENCE AND STRICT LIABILITY) OR OTHER THEORIES. BUYER'S FAILURE TO SUBMIT A CLAIM AS PROVIDED ABOVE SHALL SPECIFICALLY WAIVE ALL CLAIMS FOR DAMAGES OR OTHER RELIEF, INCLUDING BUT NOT LIMITED TO CLAIMS BASED ON LATENT DEFECTS.
- IN NO EVENT SHALL BUYER BE ENTITLED TO INCIDENTAL OR CONSEQUENTIAL DAMAGES.
- ANY ACTION BY BUYER ARISING HEREUNDER OR RELATING HERETO, WHETHER BASED ON BREACH OF CONTRACT, TORT (INCLUDING NEGLIGENCE AND STRICT LIABILITY) OR OTHER THEORIES, MUST BE COMMENCED WITHIN ONE (1) YEAR AFTER THE CAUSE OF ACTION ACCRUES OR IT SHALL BE BARRED.
- D.** In the event certifications are required, certifications are based on adherence to rigid fabrication, assembly and test procedures during production at our manufacturing facility and attest to the condition of the product at the time of shipment. Any disassembly, modifications, testing, tampering or inadequate storage of products covered by the certifications will void the certifications. Should disassembly or re-setting of this product be necessary, such work must be conducted in the presence of, and under procedures approved by Seller in order to maintain validity of the certifications.

For the name and location of the nearest sales representative, contact the Stratford sales office.

World Headquarters

Ashcroft Inc.
250 E. Main Street
Stratford, CT 06614-5145
U.S.A.
Tel: (203) 378-8281
Fax: (203) 385-0402
(Domestic)
Fax: (203) 385-0357
(International)
email: info@ashcroft.com
www.ashcrodt.com

Visit our web site at www.ashcroft.com

All specifications are subject to change without notice. All sales subject to standard terms and conditions.
© 2014 Ashcroft Inc., I&M002-10233